

YM 5655 DE > 31AT623D643 (2005) > FRÄSGEHÄUSE, SCHNECKE, SCHNECKENANTRIEB

YM 5655 DE

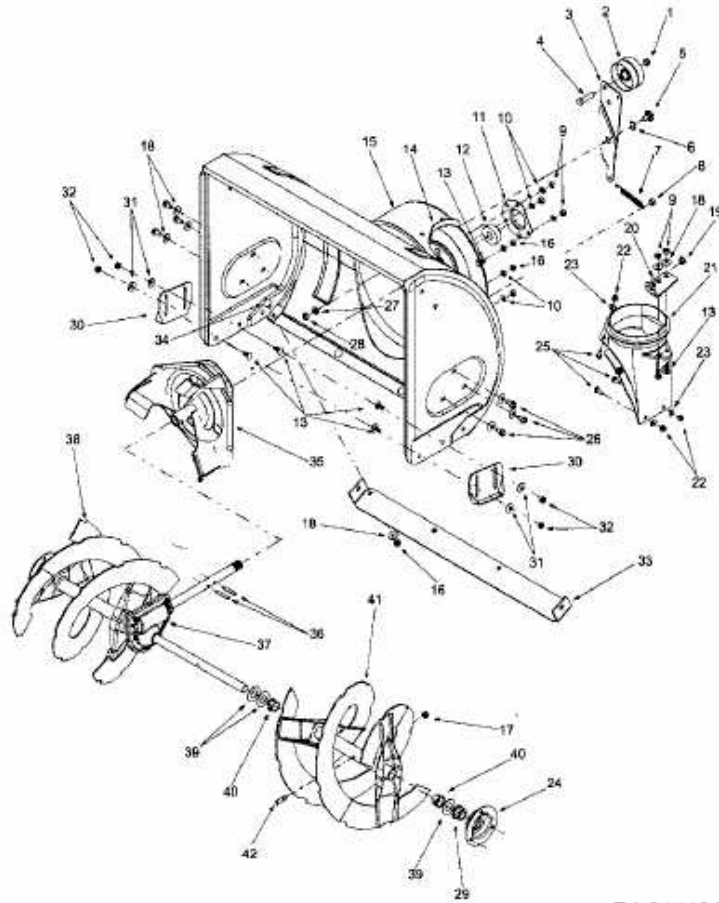

E4-01119A