

221 LHP > 31AR2T6D603 (2014) > KEILRIEMEN, MOTOR, TANK

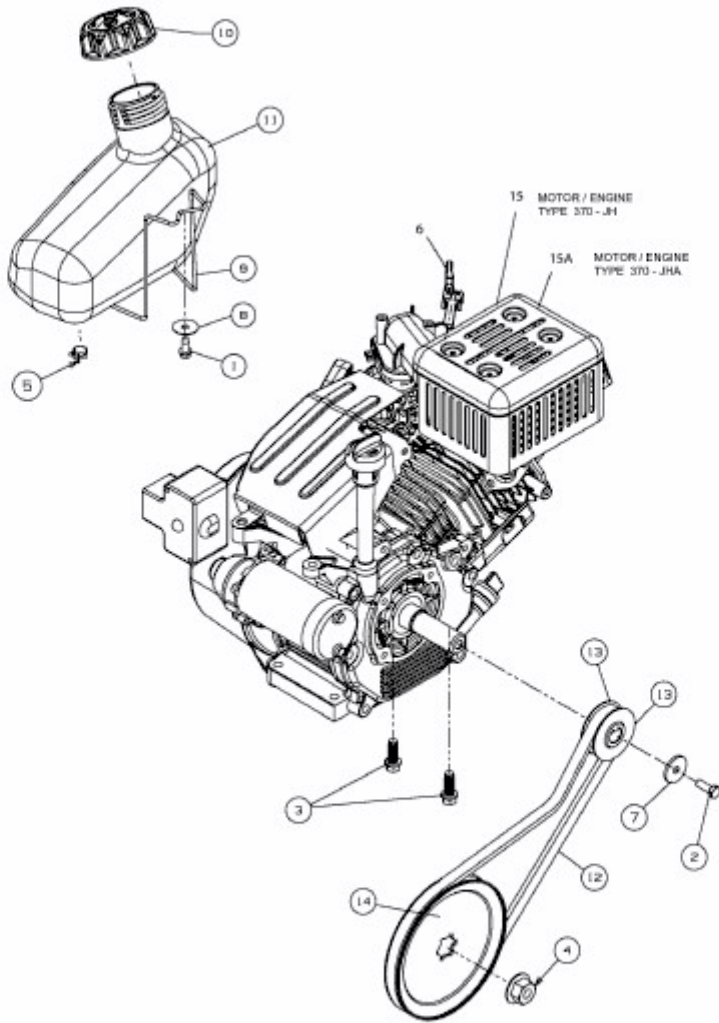

E3-07239A-01