

221 LHP > 31AR2T6D603 (2014) > FRÄSGEHÄUSE, SCHNECKE, UNTERHOLM

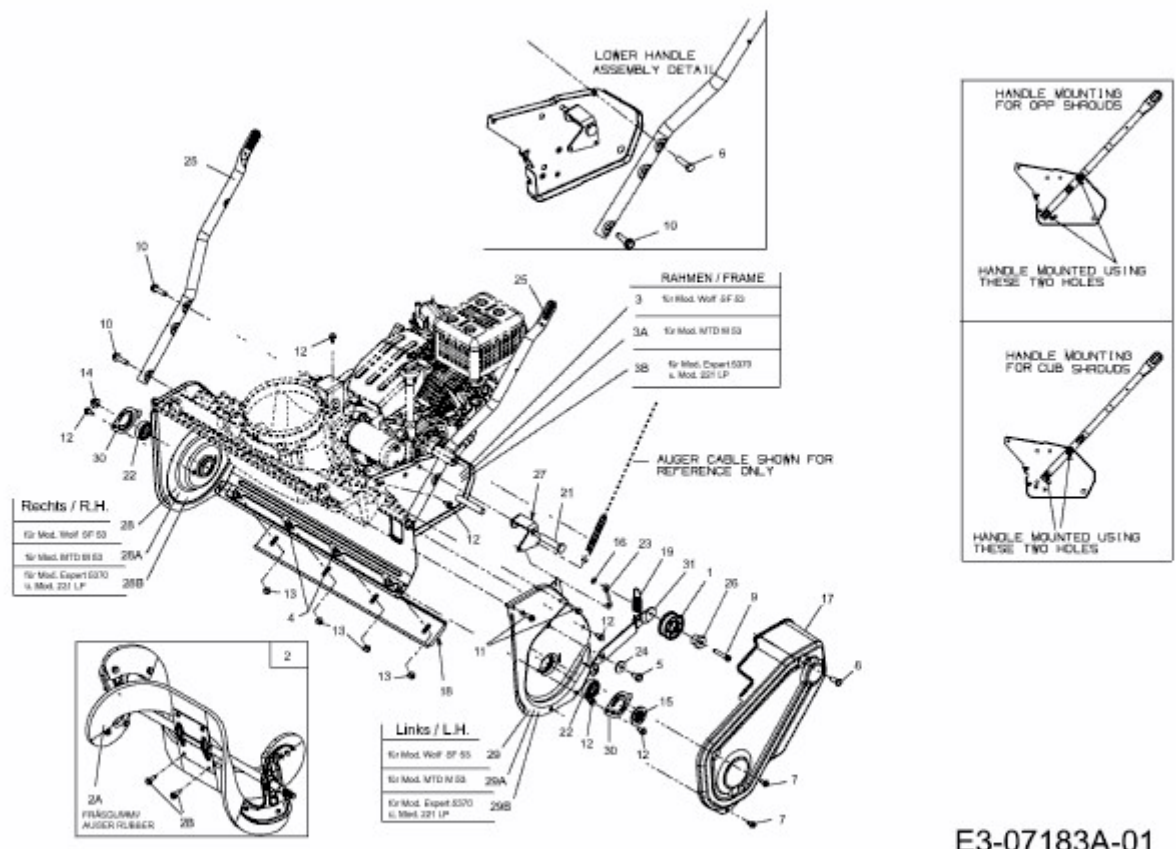

E3-07183A-01