

H 553 G > 31AH553G401 (2002) > FAHRANTRIEB, FRÄSANTRIEB

H 553 G

31AH553G401

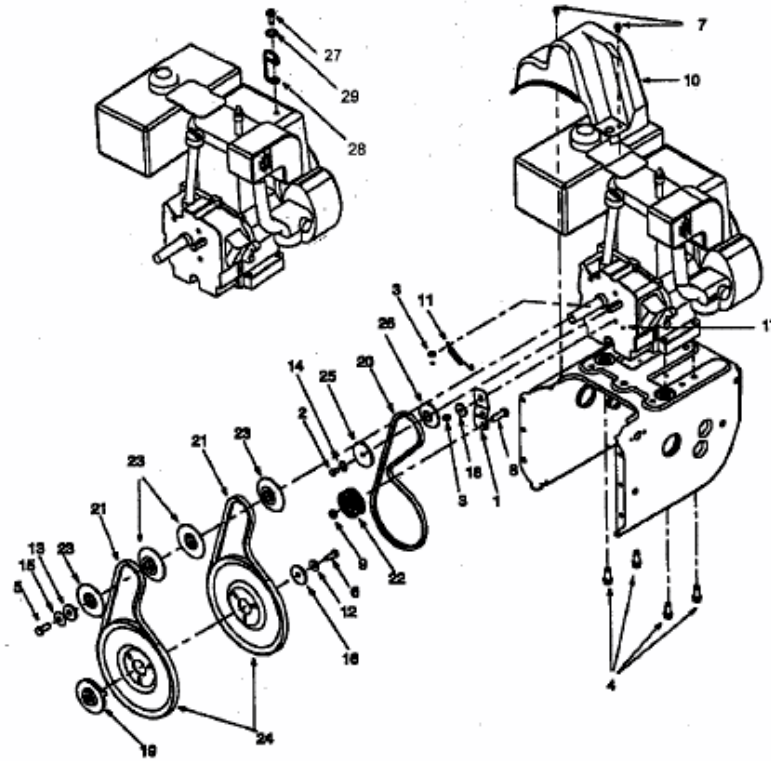

E4-01130A