

E 993 I > 31AE993I643 (2000) > FAHRANTRIEB

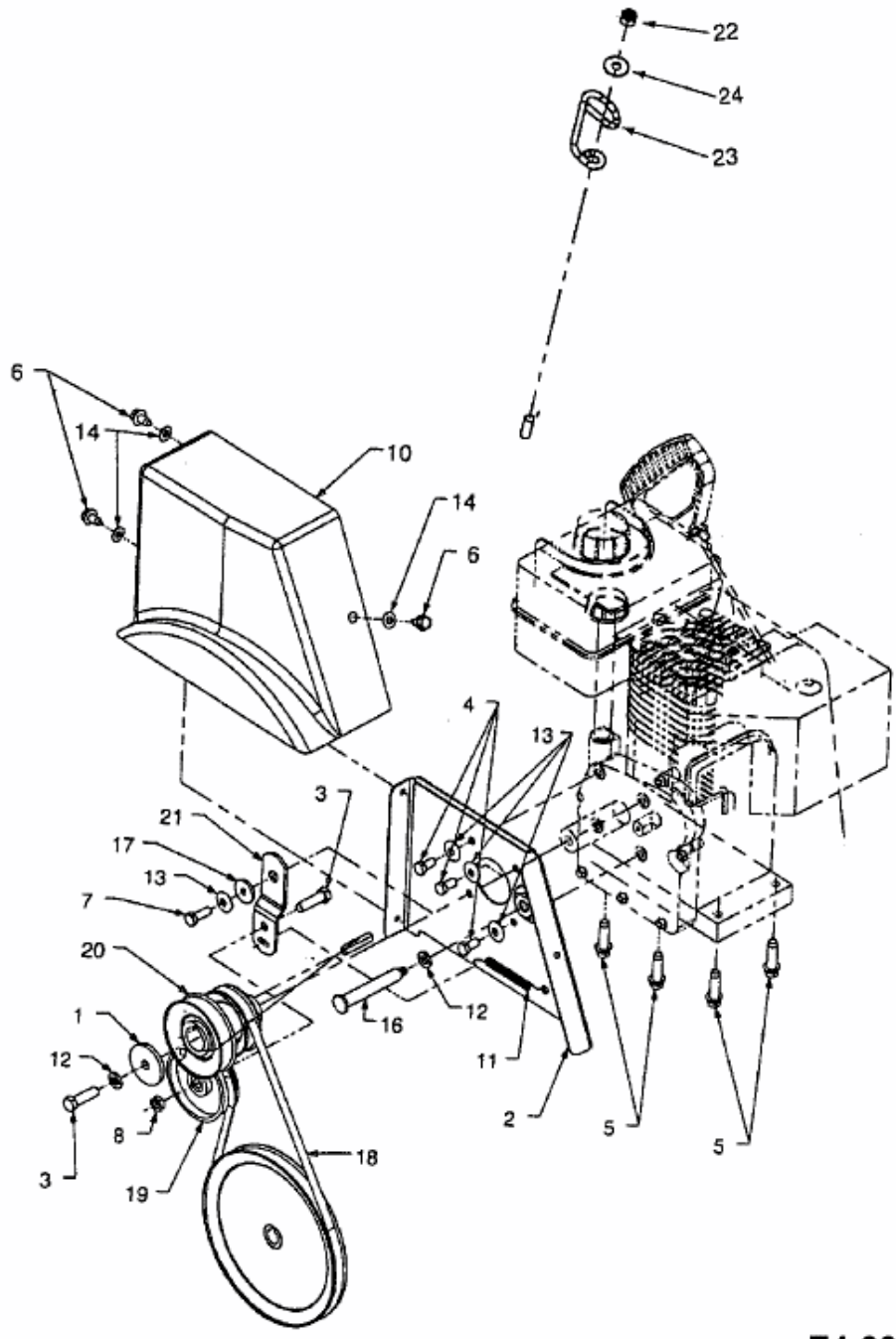

E4-00311A-01