

E 993 I > 31AE993I643 (1999) > FAHRANTRIEB, RÄDER

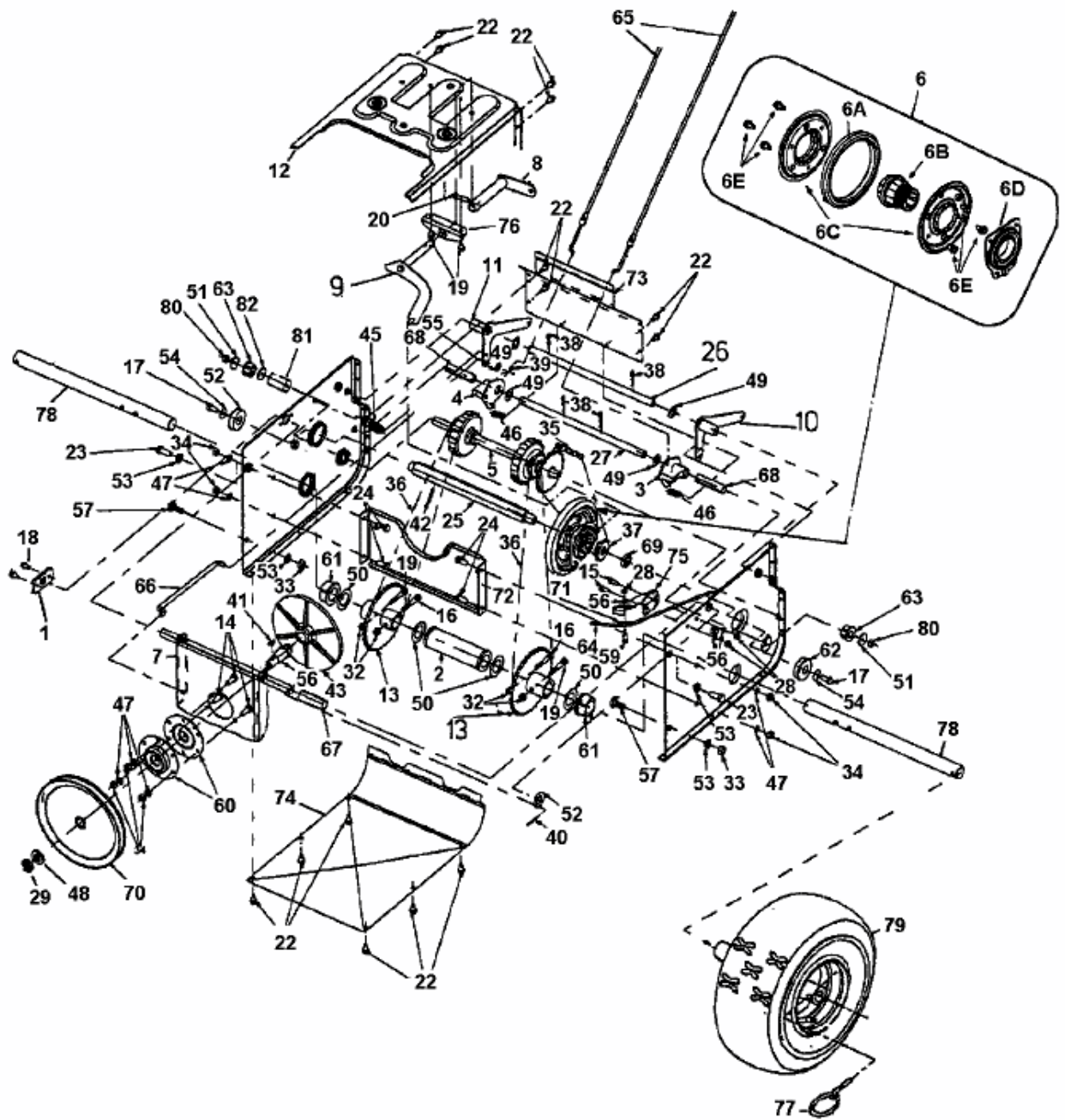

E4-00312B-01

feg