

E 7 E 3 F > 31AE7E3F643 (2001) > FAHRANTRIEB

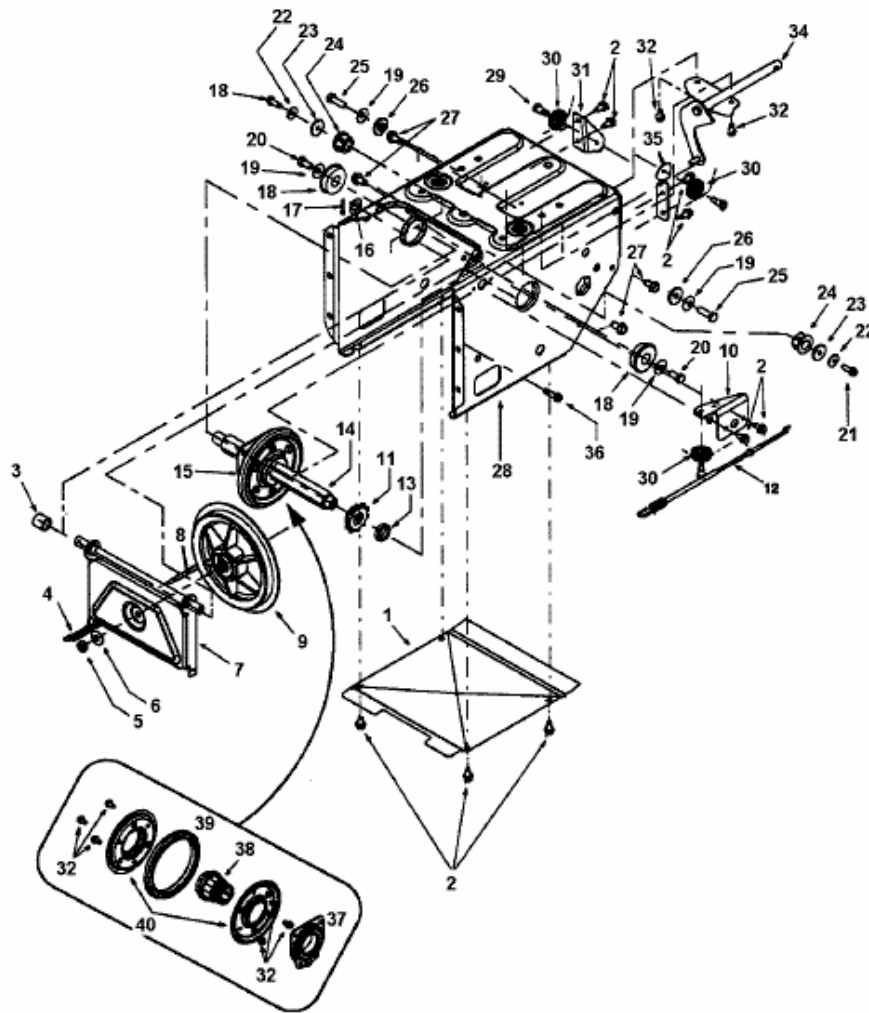

fig

E4-00959A-01