

E 753 F > 31AE753F643 (1998) > FAHRANTRIEB, FRÄSANTRIEB

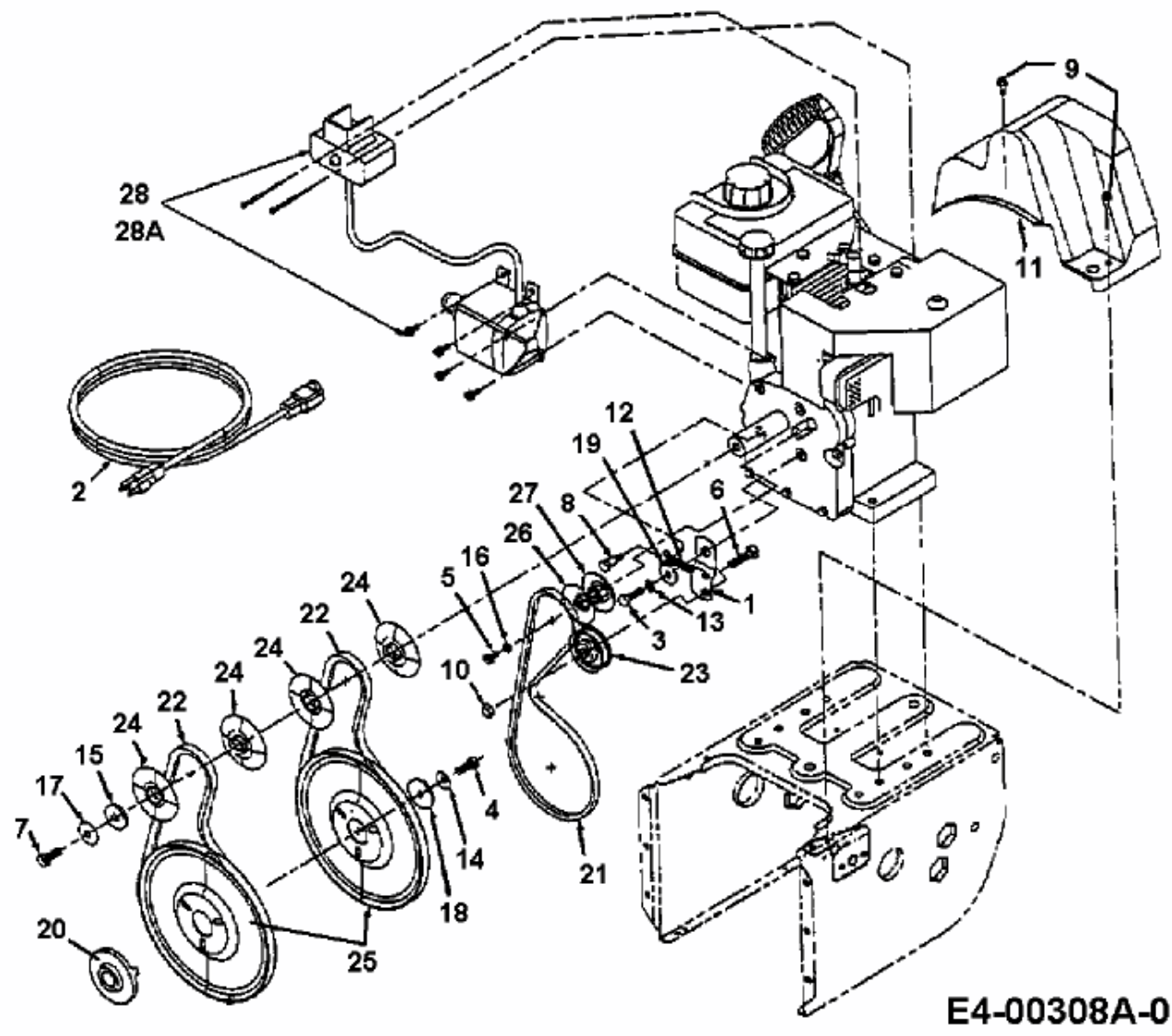

fag

E4-00308A-01