

E 753 F > 31AE753F643 (1998) > ARMATURENBRETT, AUSWURFSCHACHT, HOLM

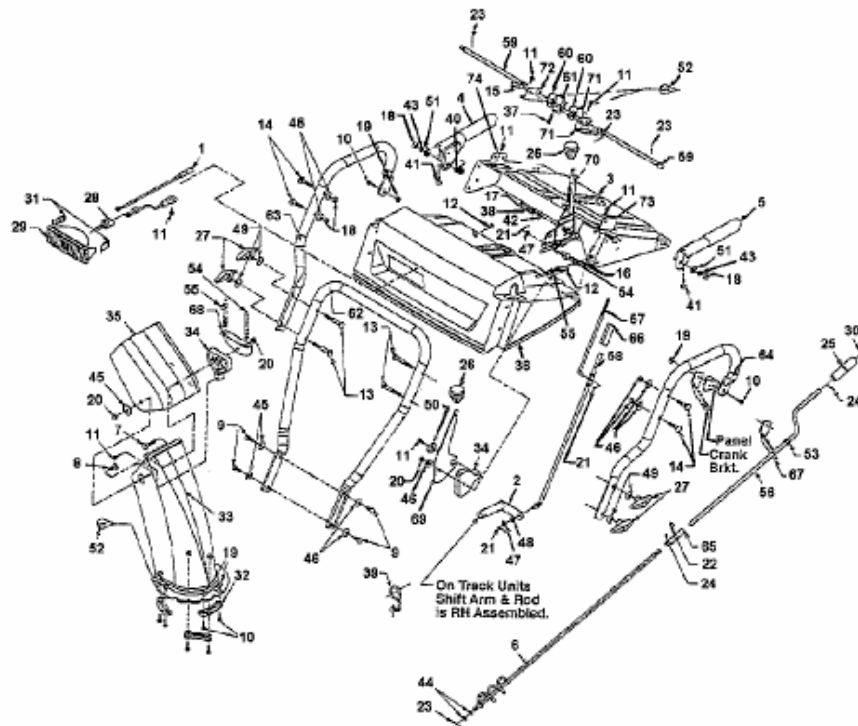

E4-00304A-01

Fig.