

E 653 F > 31AE653F643 (1999) > FAHRANTRIEB, FRÄSANTRIEB

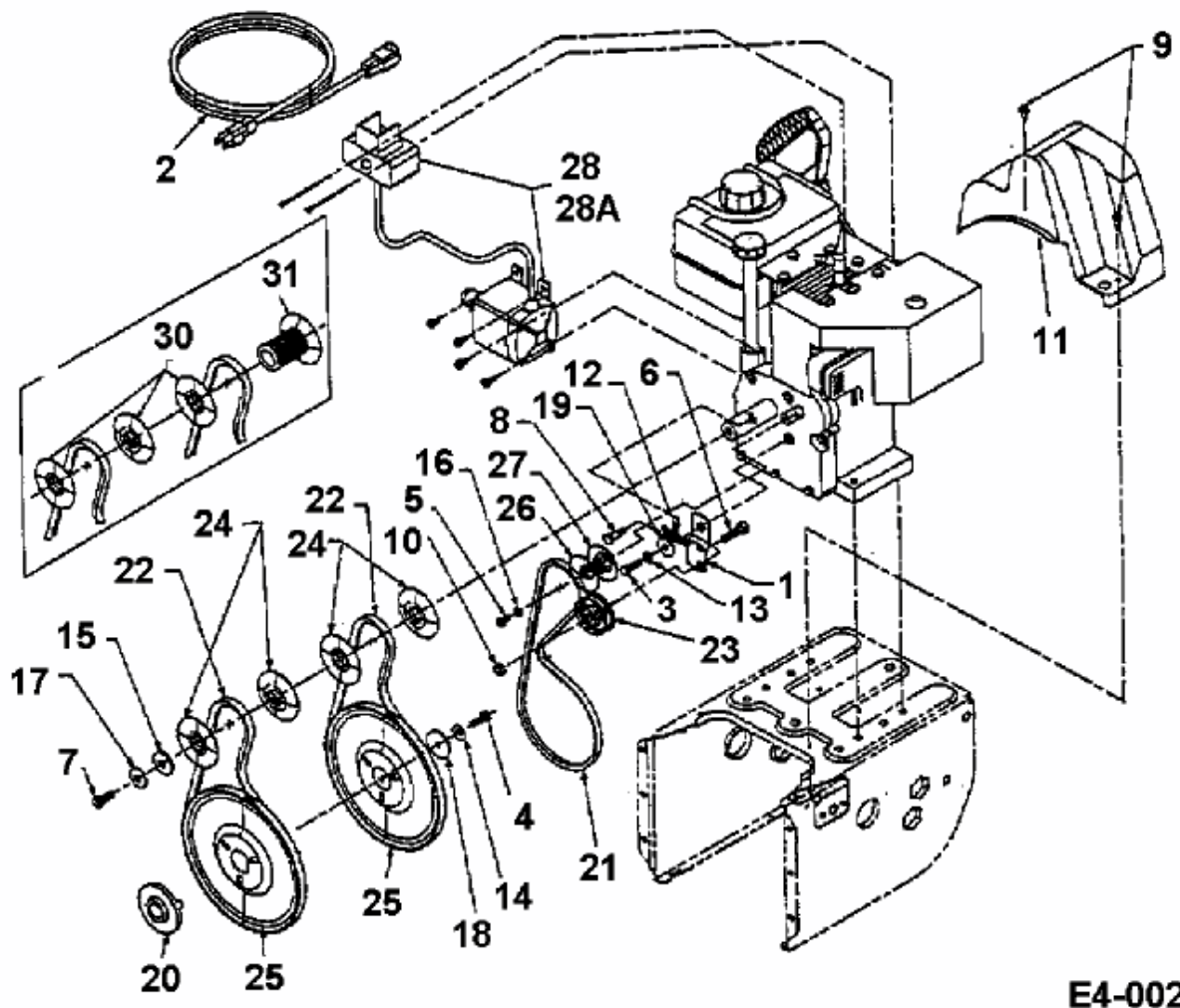

fsg

E4-00293A-01