

E 653 F > 31AE653F643 (1998) > FRÄSGEHÄUSE, SCHNECKE, SCHNECKENANTRIEB

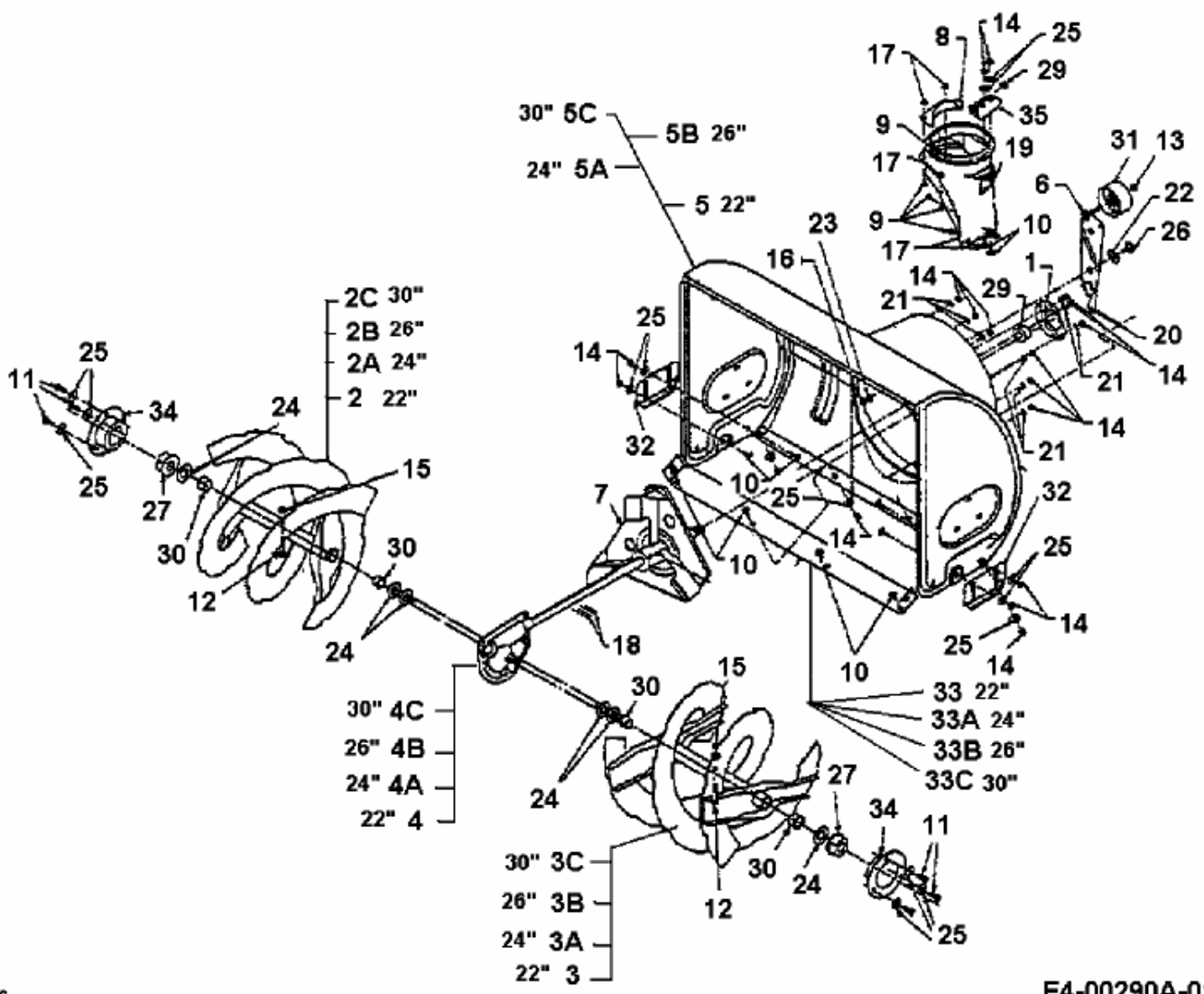

fsg

E4-00290A-01