

E 5 E 3 F > 31AE5E3F643 (2001) > FRÄSGEHÄUSE, SCHNECKE, SCHNECKENANTRIEB

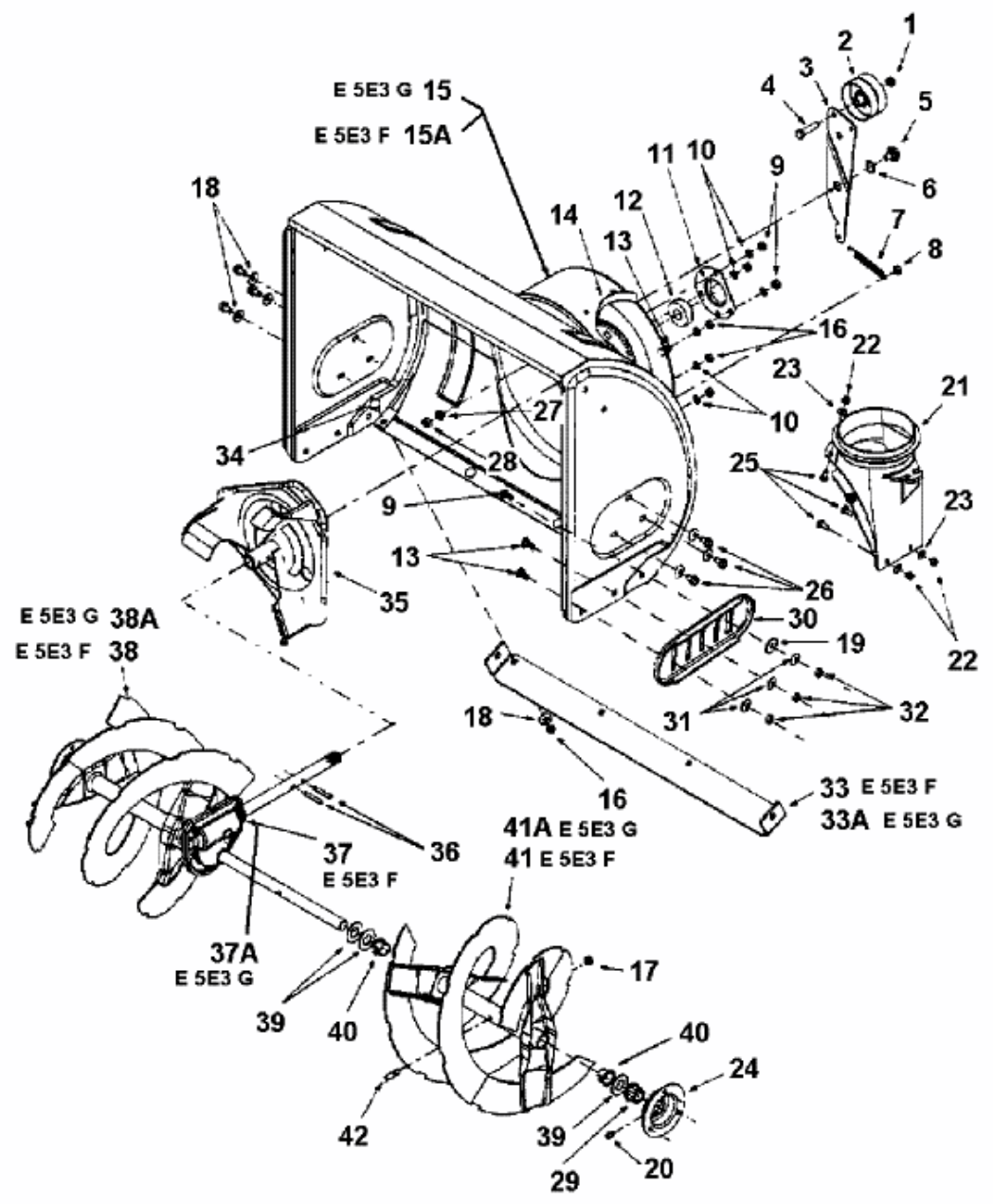

fsq

E4-00949A-01