

E 5 E 3 F > 31AE5E3F643 (2000) > FAHRANTRIEB, FRÄSANTRIEB

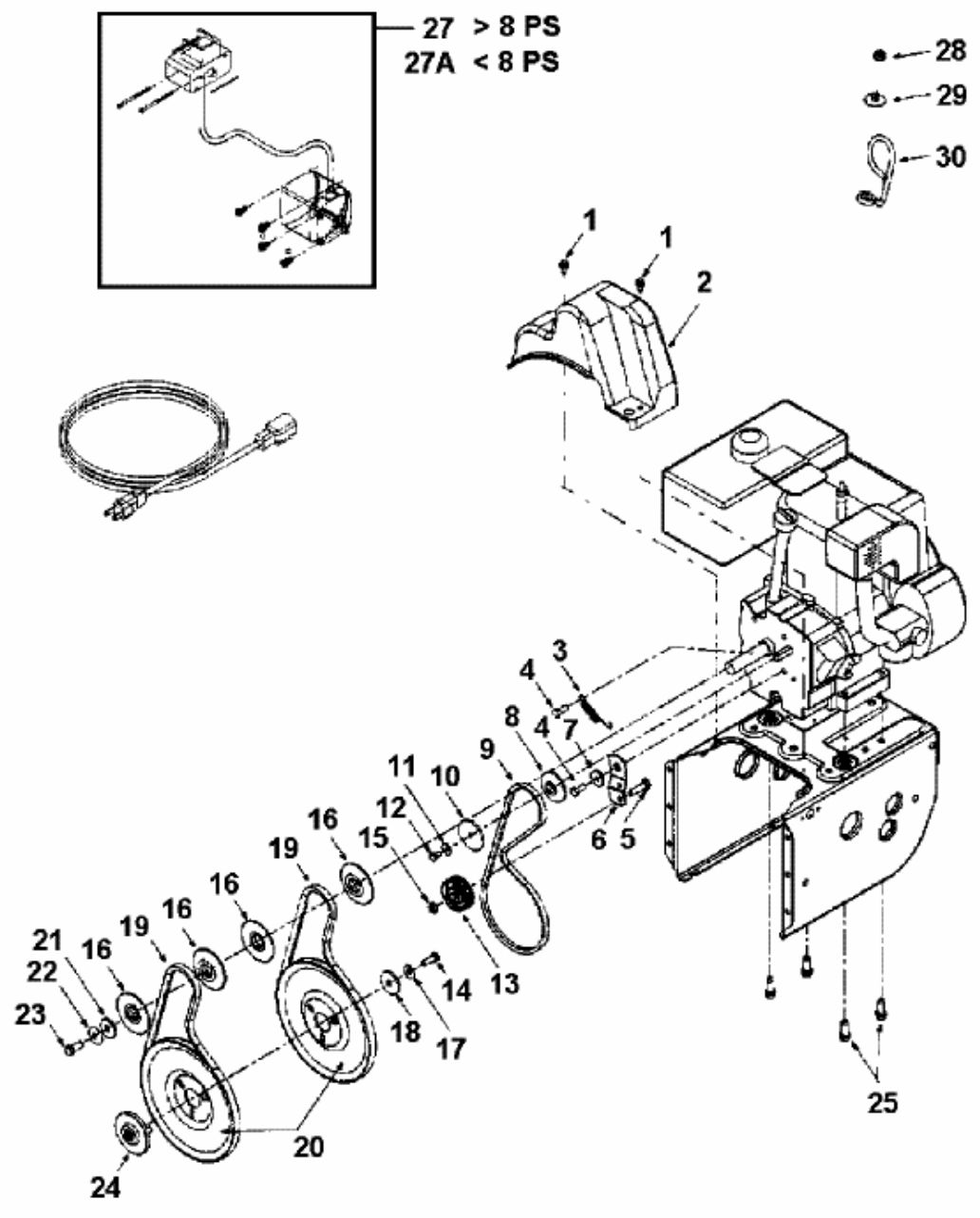

fsg

E4-00953A-01