

E 5 E 3 F > 31AE5E3F643 (2000) > SCHNECKENGETRIEBE

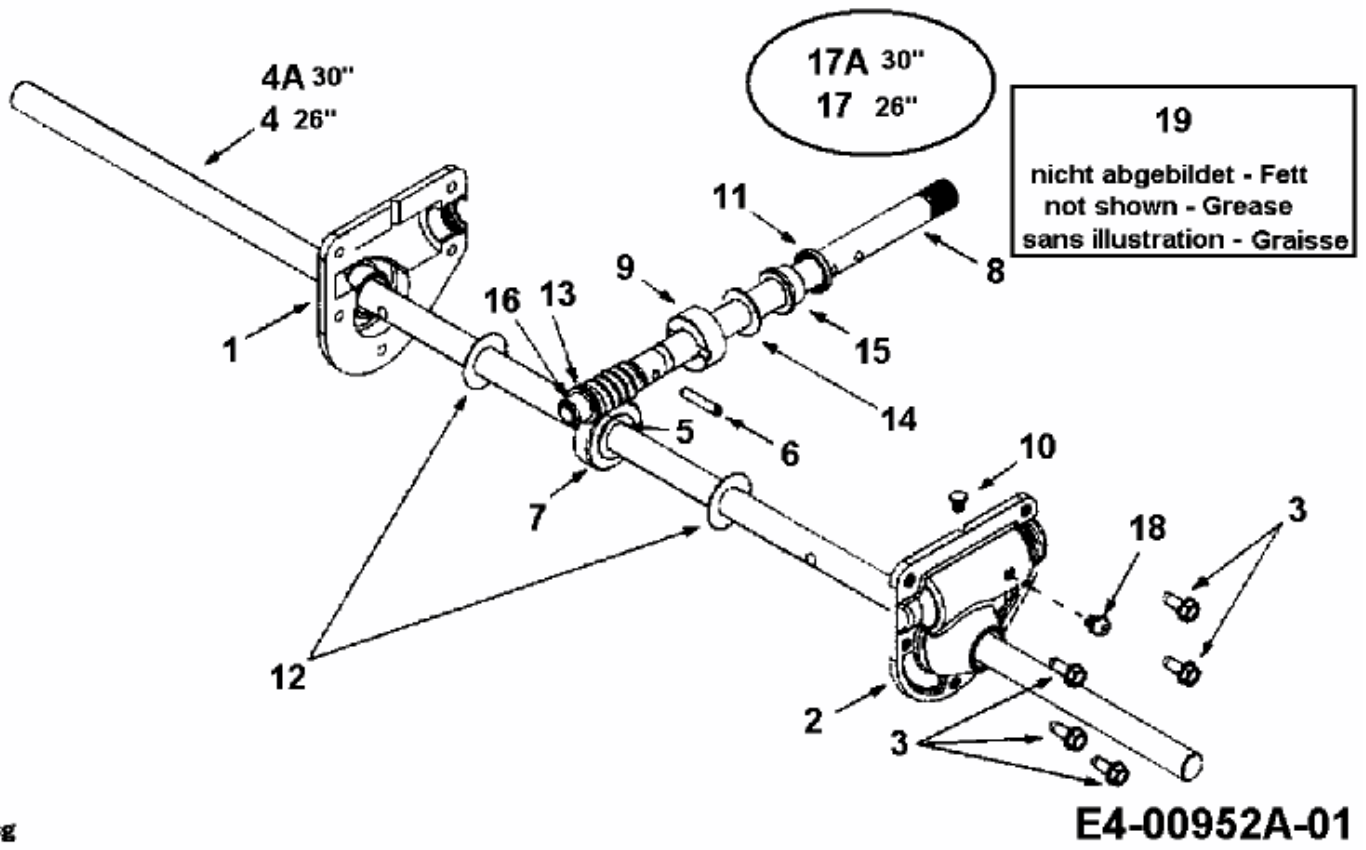

fsg