

E 5 E 3 F > 31AE5E3F643 (1999) > EINGRIFFSCHUTZ AUSWURFSCHACHT, HOLZSTÖSSEL

SCHNEEFRÄSEN /
SNOW THROWERS

Models 140 ,150 ,611D ,641E , E640F , E660G

Models 623D ,533E ,5E3F ,7E3F , E 740F

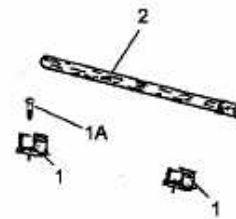
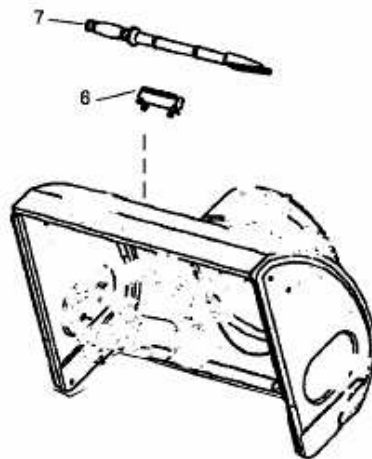
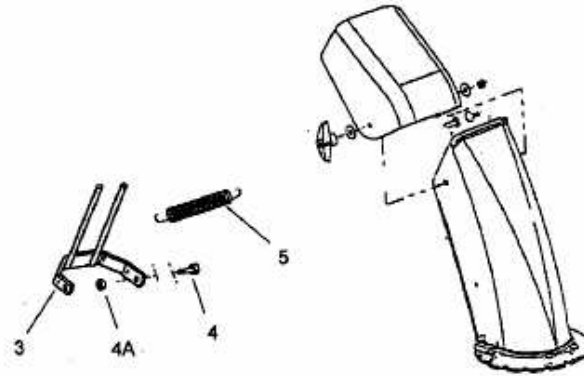

Alternative

E3-01516B