

E 5 E 3 F > 31AE5E3F643 (1999) > SCHNECKENGETRIEBE

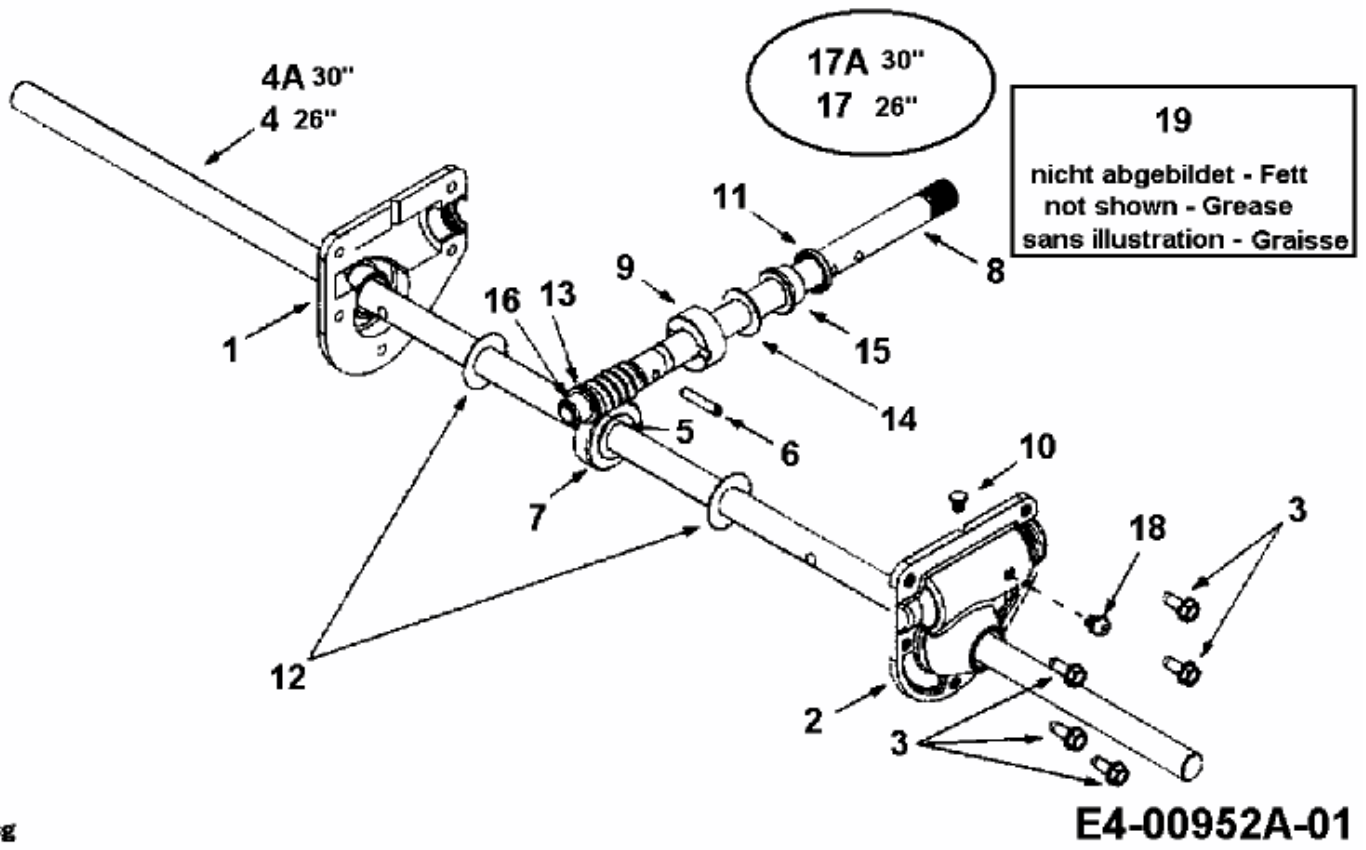

fsg