

POLAR 3053 > 31A-2M5-609 (2008) > MOTORABDECKUNG

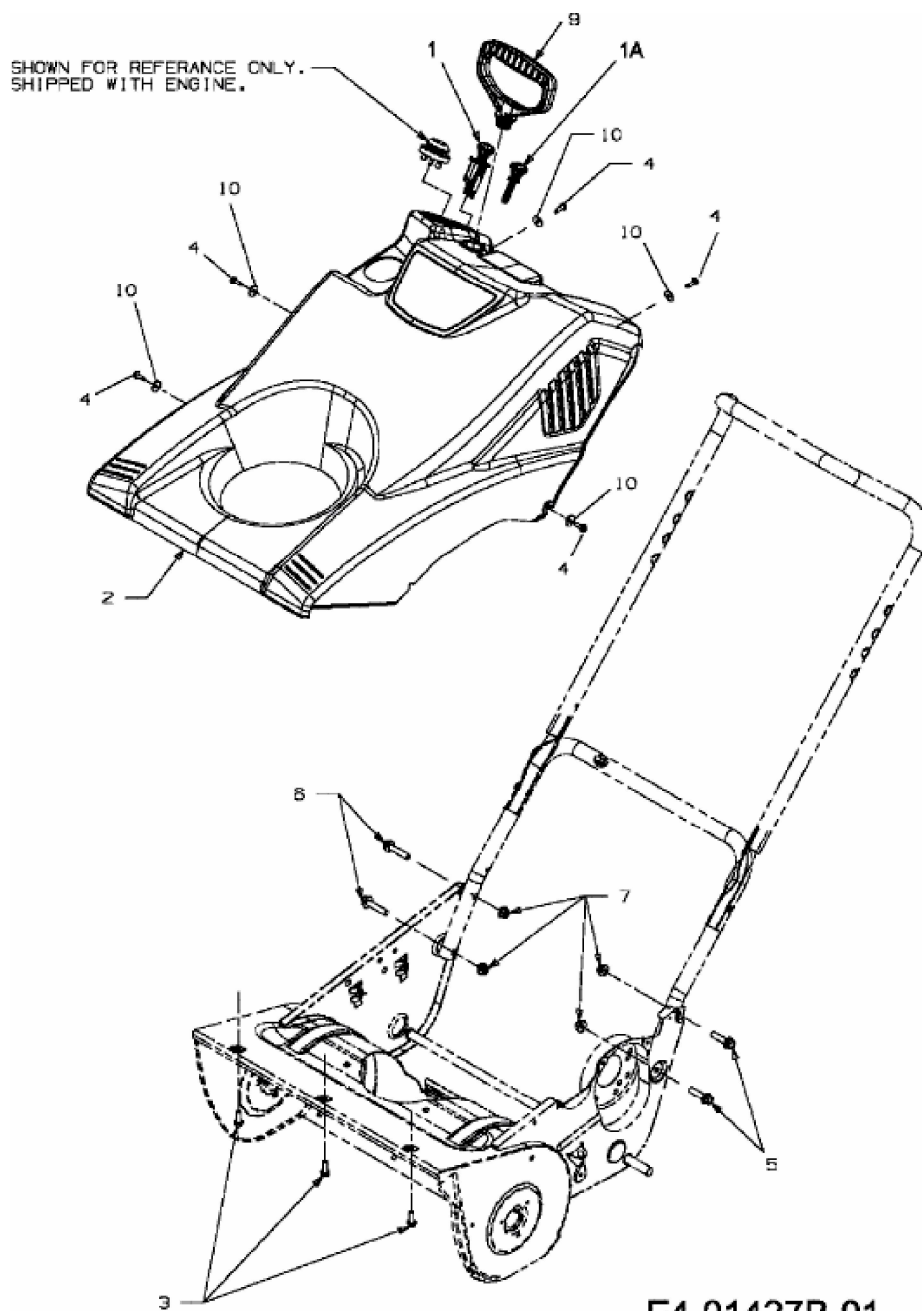

E4-01427B-01