

SELECT SF 53 > 31A-2M1E650 (2014) > FRÄSGEHÄUSE, SCHNECKE, UNTERHOLM

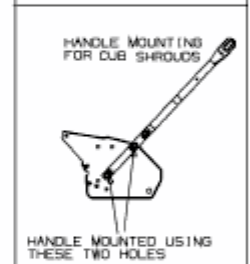
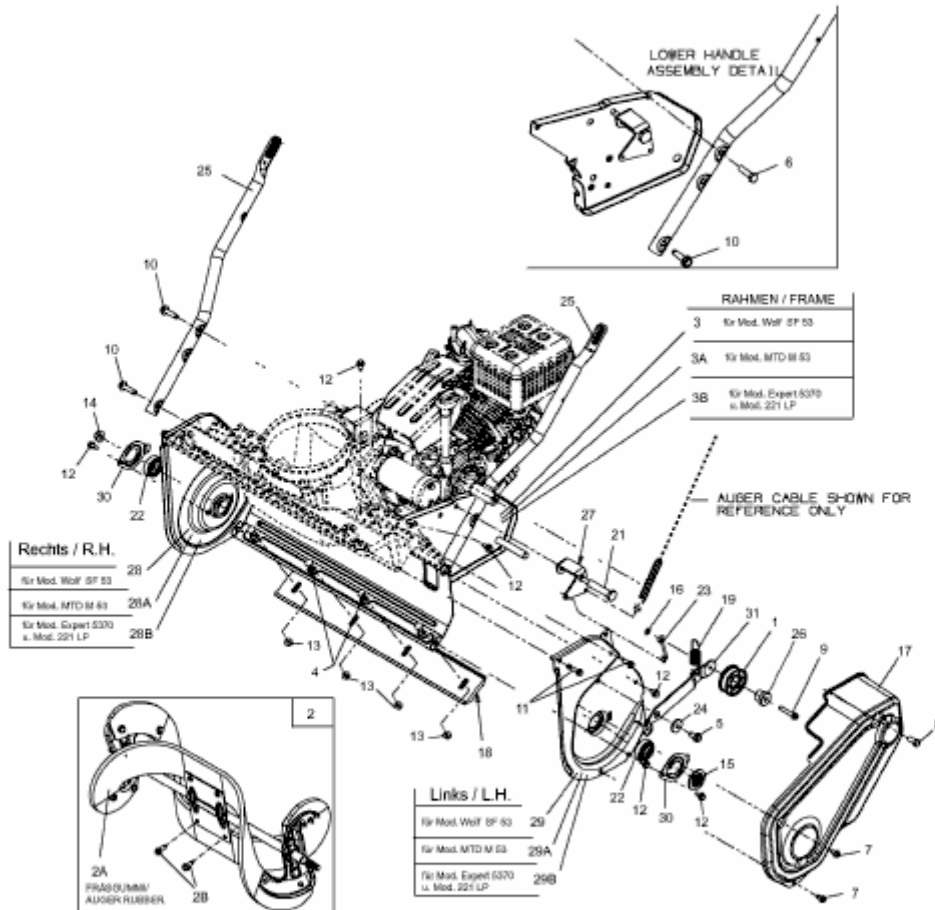

E3-07183A-01