

YM 5350 S > 31A-285-643 (2005) > FRÄSANTRIEB

YM 5350 S

31A-285-643

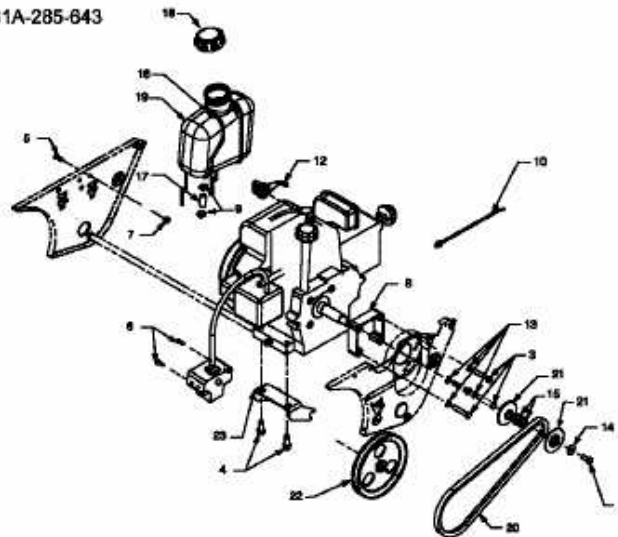

E4-01143A