

[BM 87-35](#) > [25A-FM5B678 \(2014\)](#) > [Mähbalken](#)

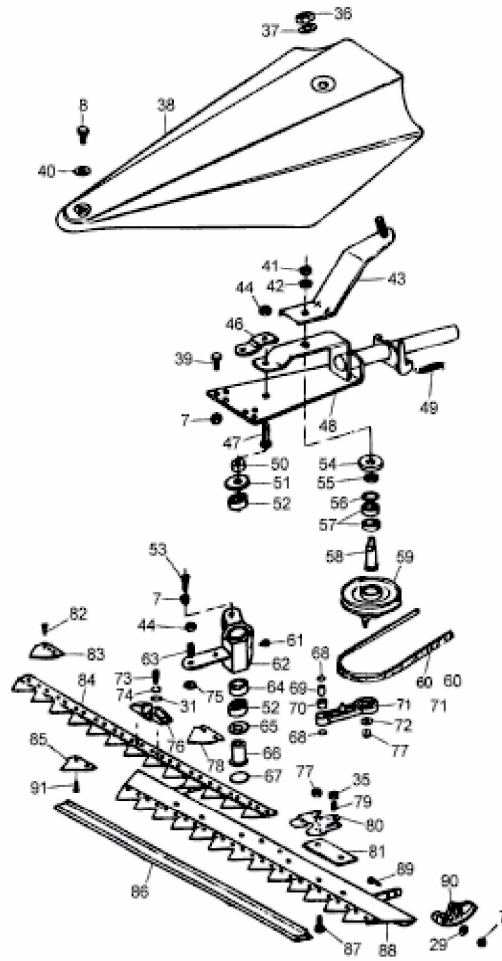

E3-07026C-02