

550 G > 24A-7512678 (2001) > GRUNDGERÄT

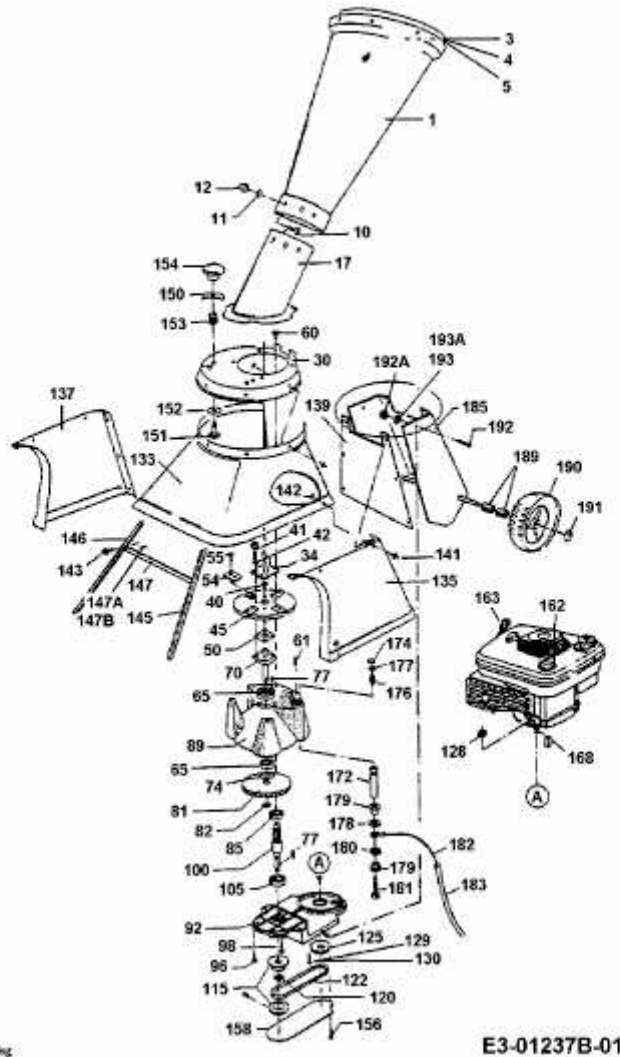

Fig.

E3-01237B-01