

T/380 M > 21C-38MT678 (2012) > KEILRIEMENSCHUTZ

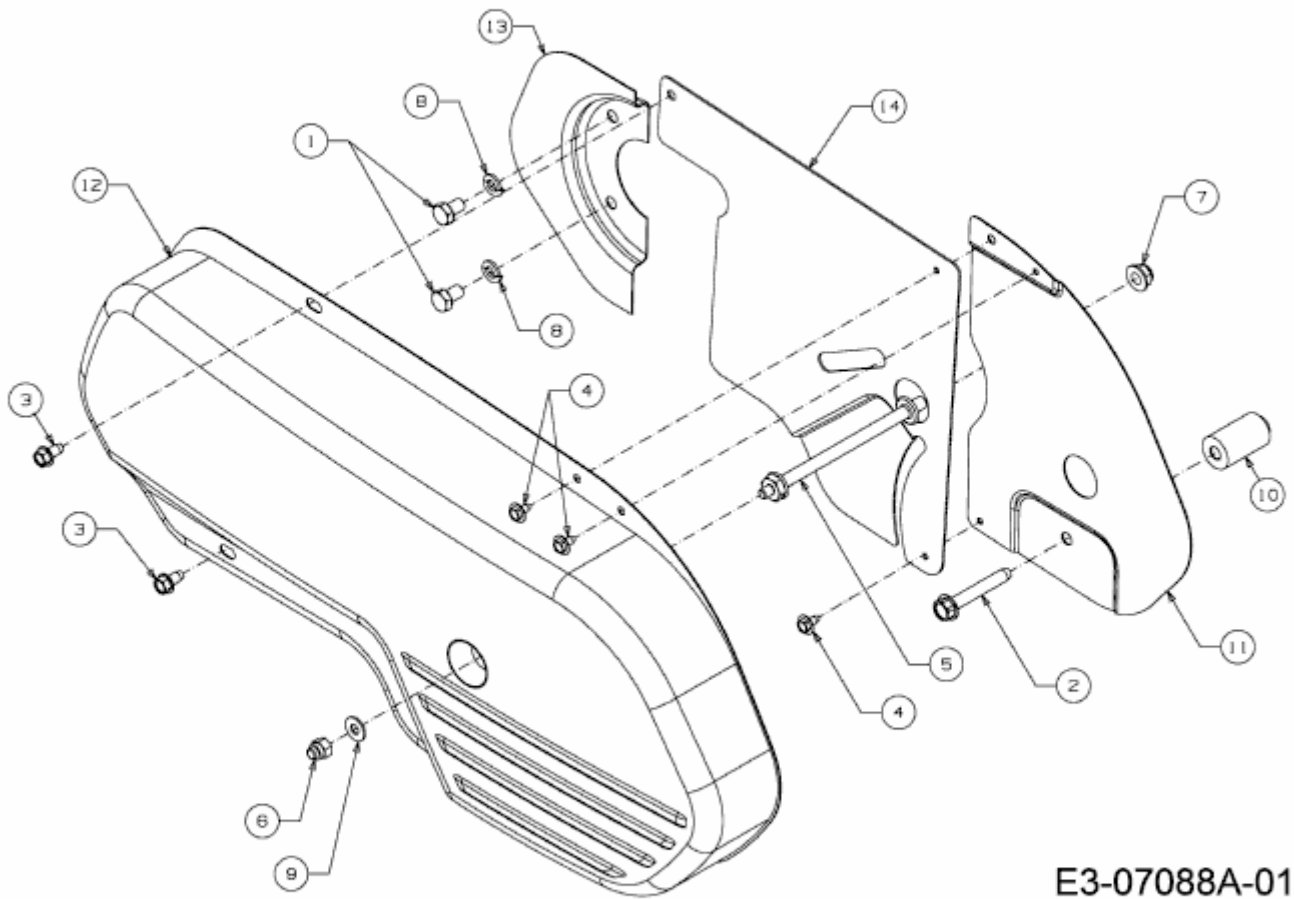

E3-07088A-01