

T/380 M > 21C-38MT678 (2012) > SPORN

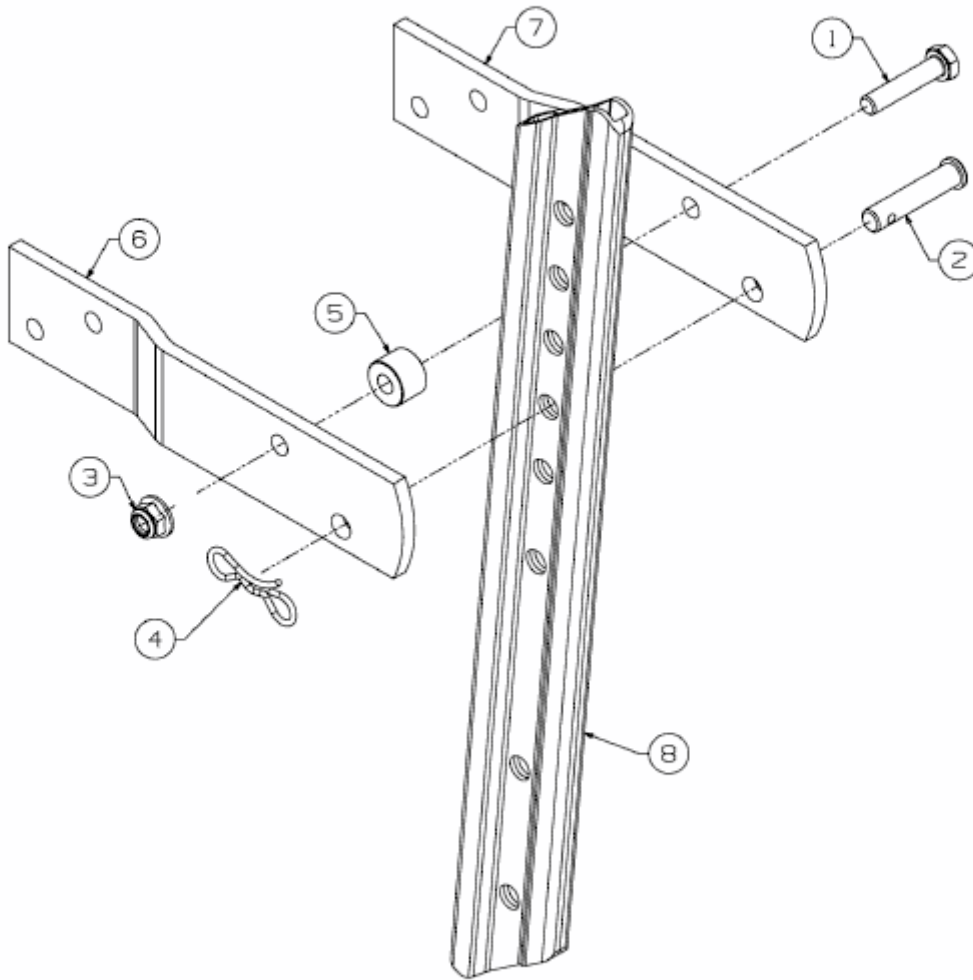

E3-07070A-01