

T/380 M > 21C-38MT678 (2011) > KEILRIEMEN, SPANNROLLE

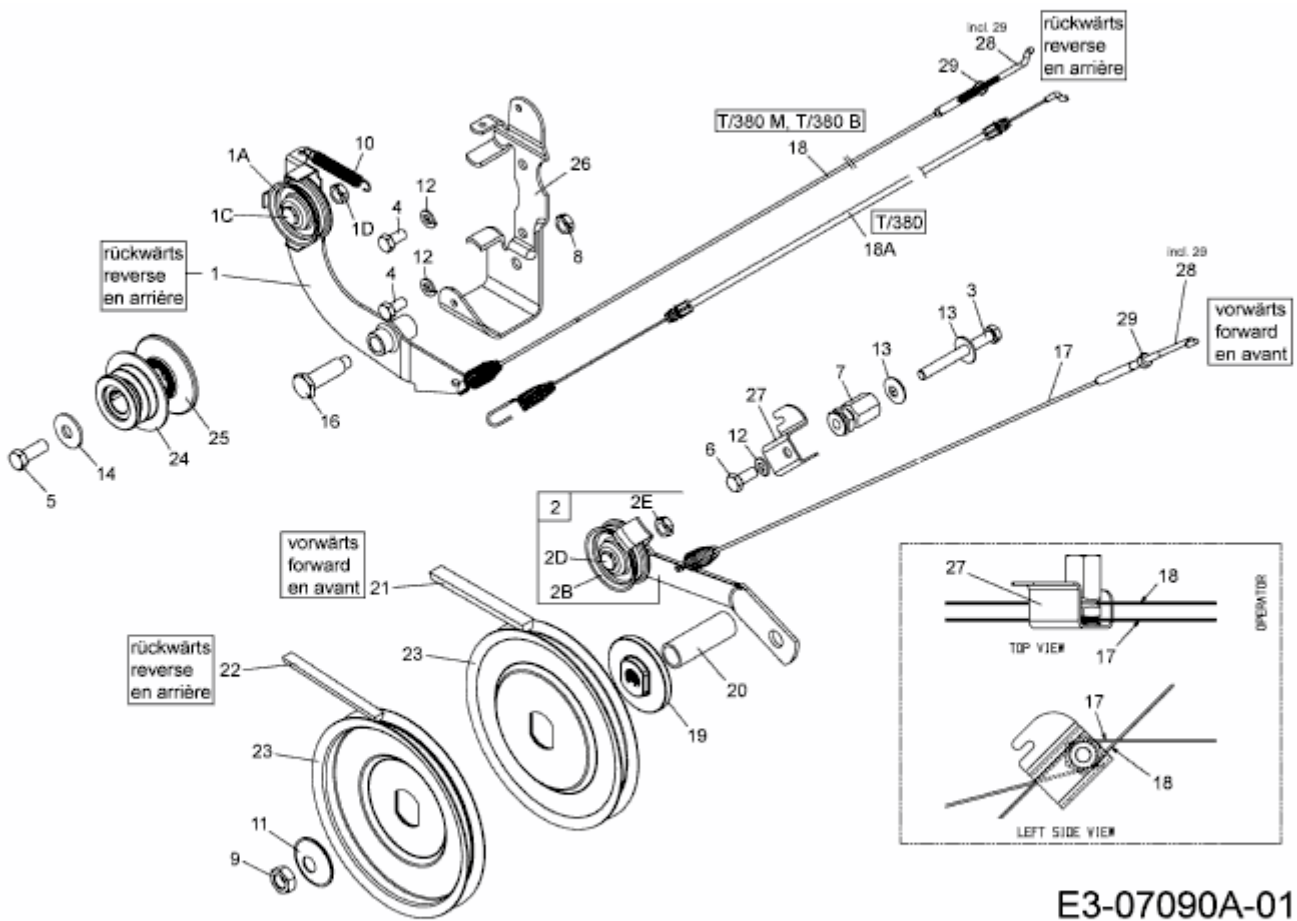

E3-07090A-01