

T/380 M > 21C-38MT678 (2009) > MOTOR, RAHMEN, SPORN

M 380 M , T/380 M , T/380
 TBT 380
 T/380 B
 MX MH 81-55R ,MX MH 81-50R
 BL 5081 GT

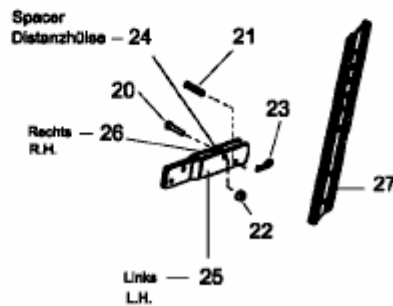
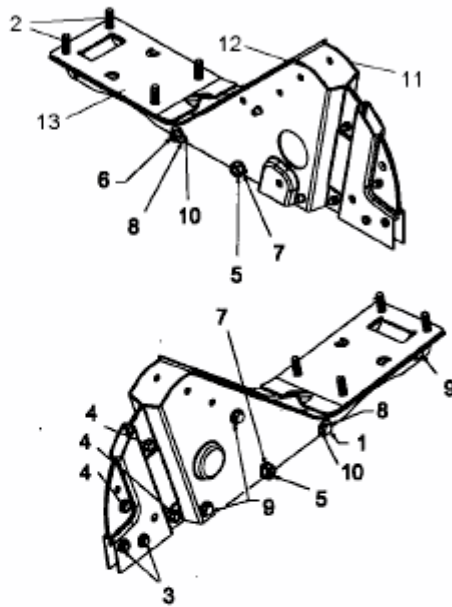

B&S - Motor , Engine B&S Nicht abgebildet / Not shown

- 18 — Berührungsschutz Auspuff / Muffler Guard
 - 19 — Schraube (4x) / Screw (Qty. 4)
 - 17 — B&S - Motor , Engine B&S
-

T/380
 TBT 380
 MX MH 81-50R

17A — B&S - Motor , Engine B&S
 für T/380 B (21C-382A602)
 for T/380 B (21C-382A602) only

HONDA-MOTOR/ ENGINE/MOTEUR Nicht abgebildet / Not shown

- 17B HONDA - Motor, Engine HONDA
 - 17C HONDA - Motor, Engine HONDA
-
- BL 5081 GT ,21B-385A684
 BL 5081 GT ,21B-385D684
 BL 5081 GT ,21C-385D684

- 17D **MTD-Motor Engine MTD**
-
- M 380 M
 T/380 M
 MX MH 81-55R

17E **TEC-Motor Engine TEC**
 für T/380 B (21C-383A602)
 for T/380 B (21C-383A602) only

E3-01990C-01