

T/380 M > 21C-38MT659 (2009) > KEILRIEMEN, SPANNROLLE

M 380 M , T/380 M , T/380 , TBT 380, T/380 B ,
MX MH 81-55R ,MX MH 81-50R ,
BL 5081 GT

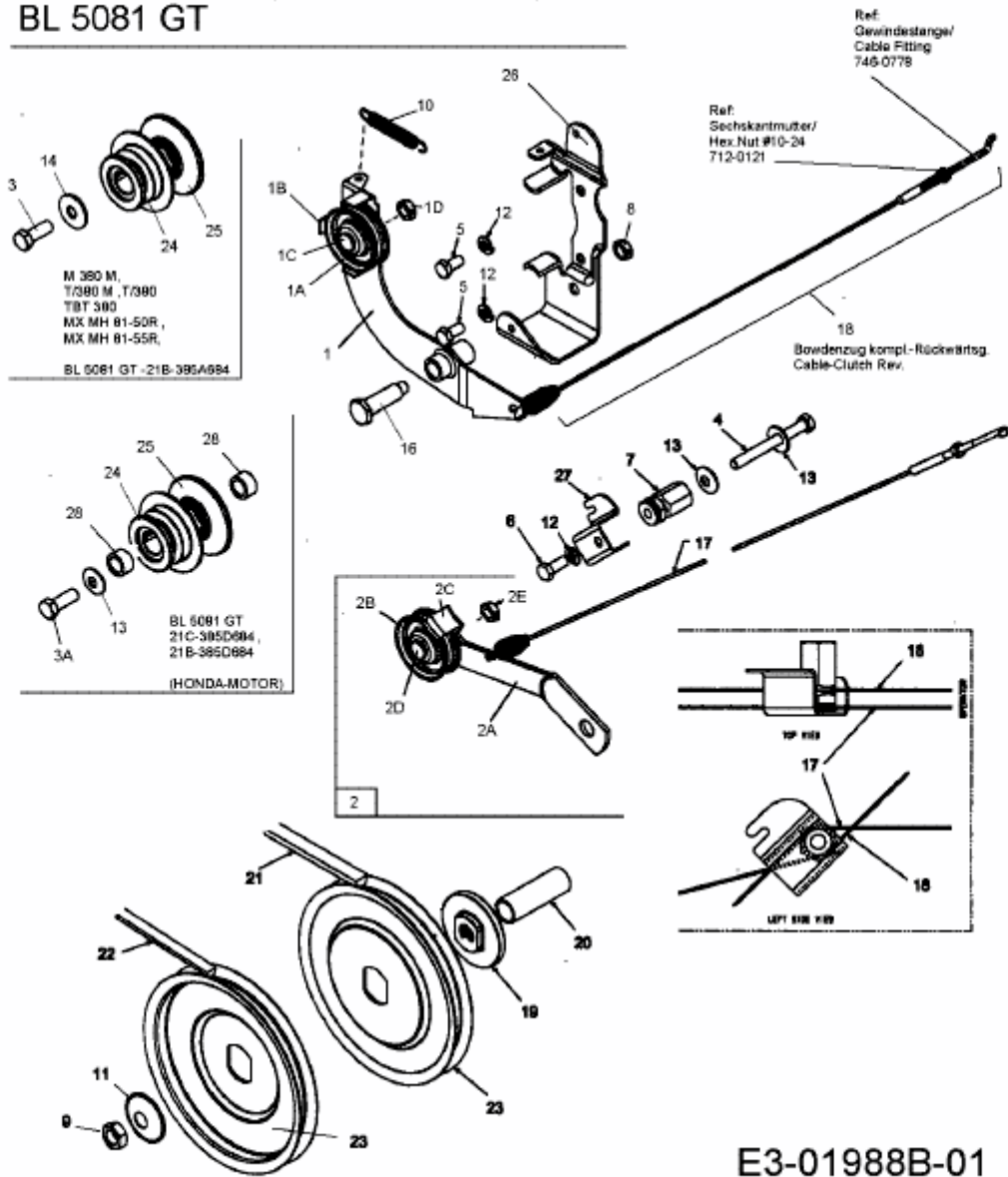

E3-01988B-01