

T/330 M > 21C-33MV678 (2013) > RADTRÄGER, RÄDER

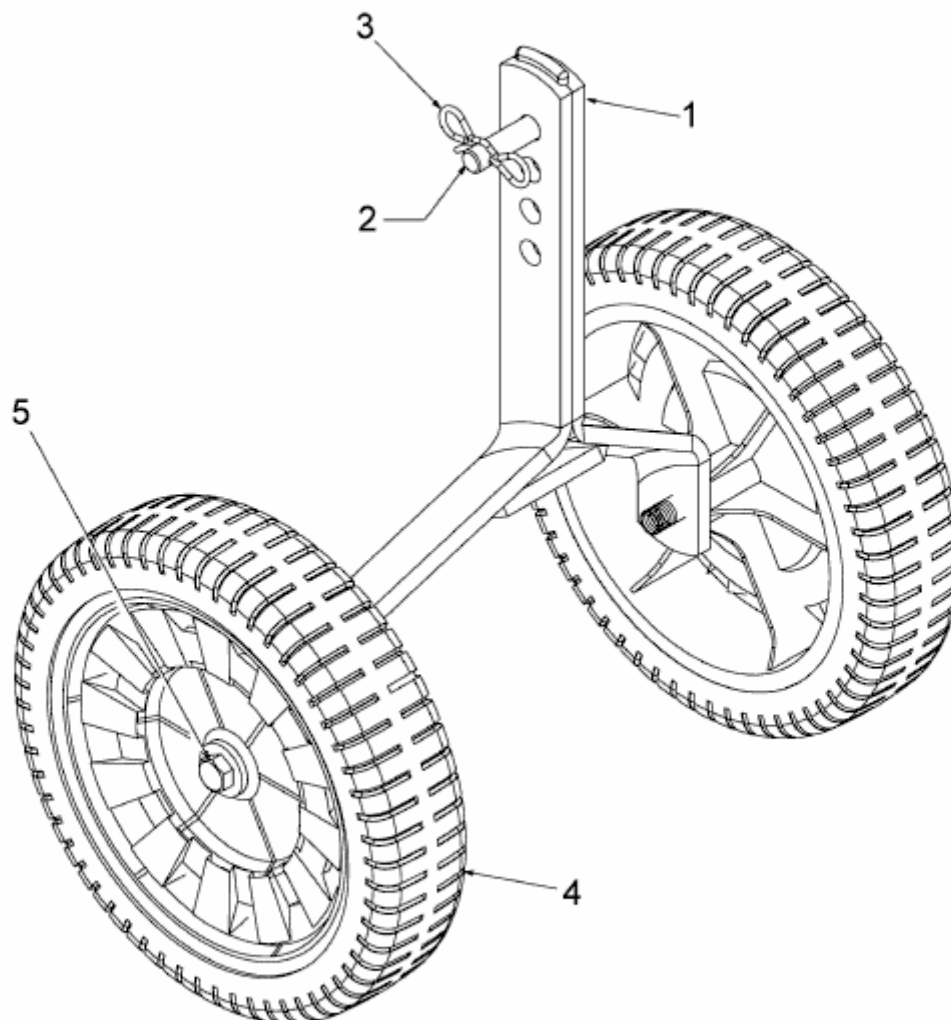

E3-07078A-01