

T/330 M > 21C-33MV678 (2013) > SCHUTZSCHILD

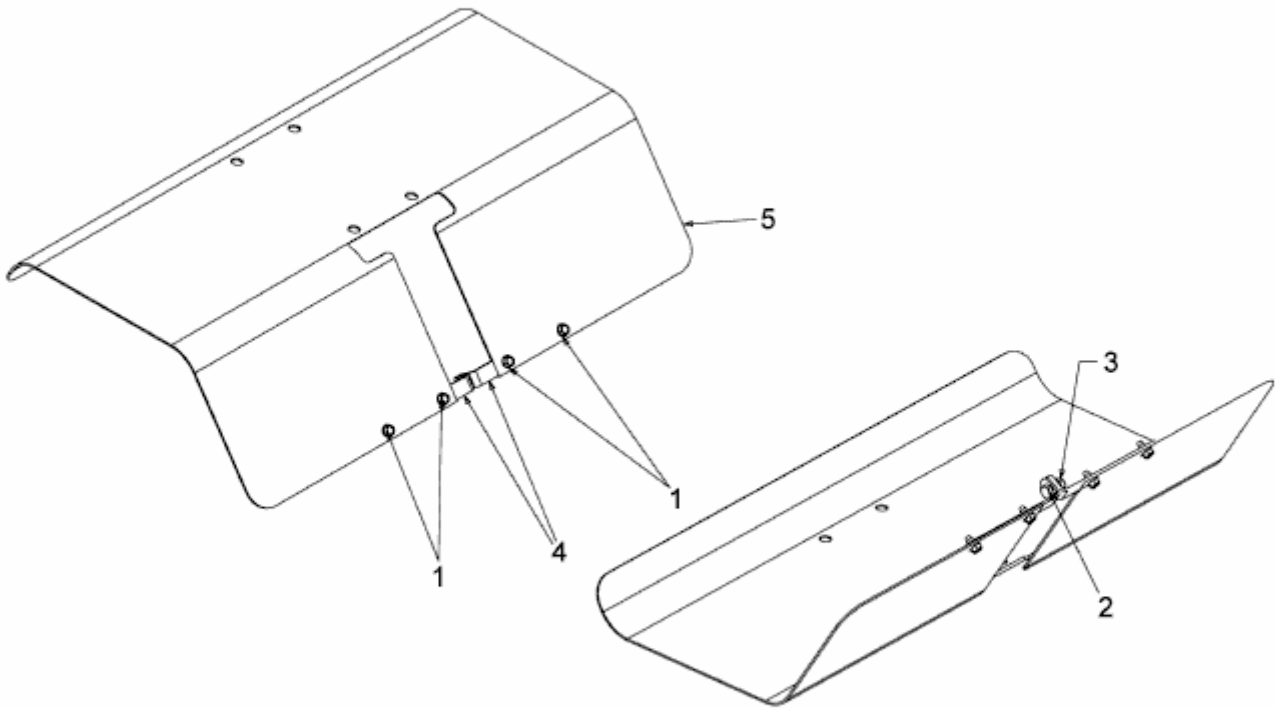

E3-07071A-01