

T/330 M > 21C-33MV678 (2013) > RAHMEN

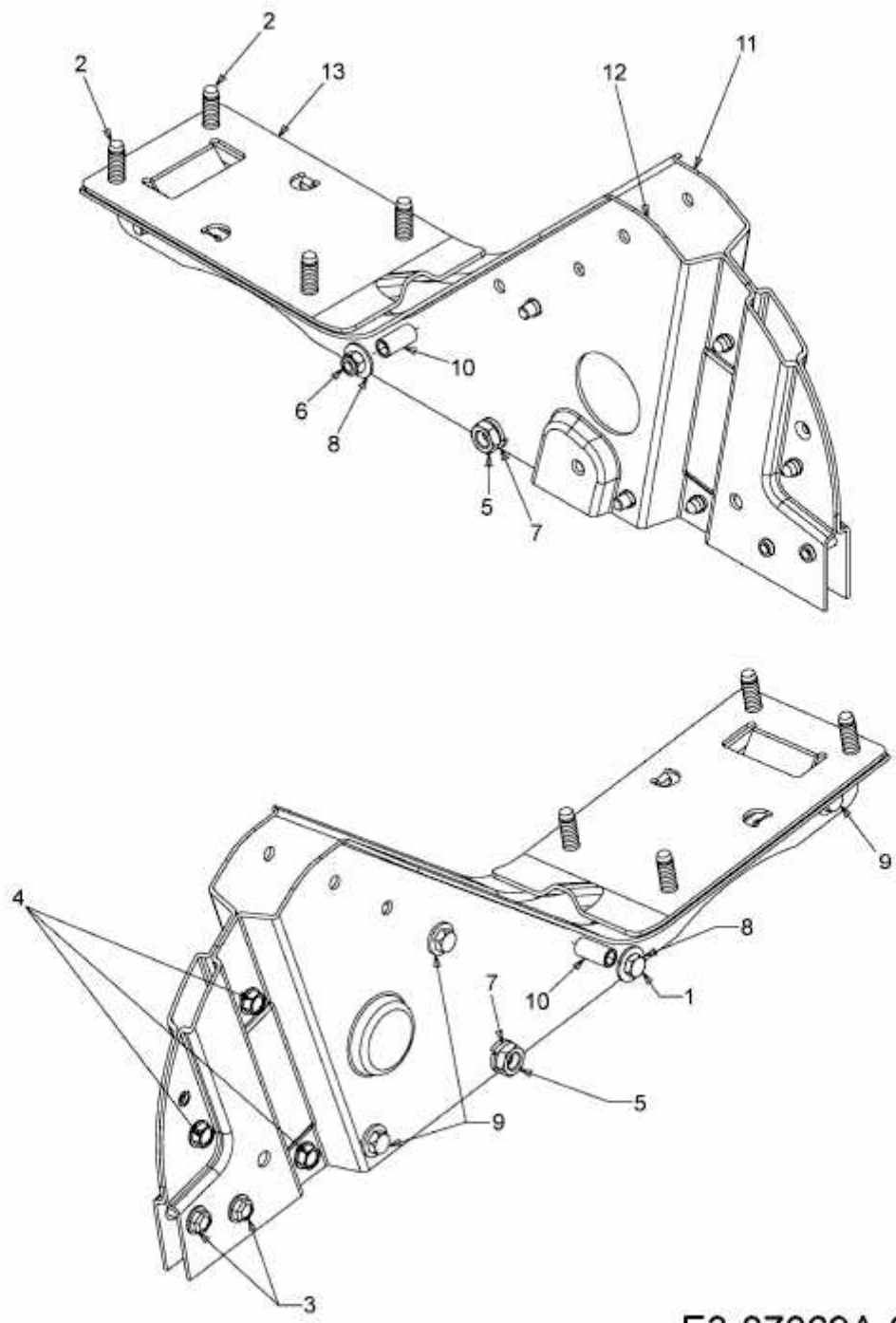

E3-07069A-01