

T 380/50 > 21B-382A678 (2007) > MOTOR, RAHMEN, SPORN

T/380  
TBT 380  
T/380 B  
MX MH 81-50R  
BL 5081 GT

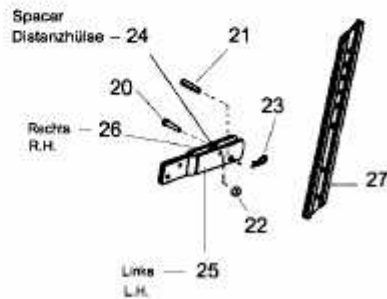
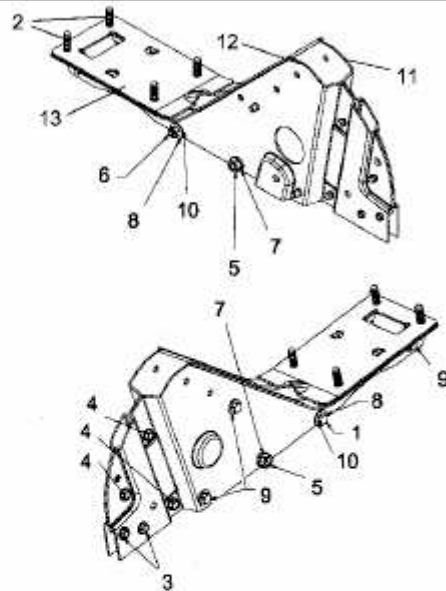

Nicht abgebildet /  
Not shown

19	Schraube (4x) Screw (Qty. 4)	
18	Berührungsschutz Auspuff/ Muffler Guard	
17	B&S - Motor, Engine B&S	17A für T/380 B for T/380 B only

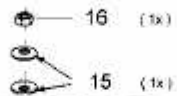

B&S - Motor,  
Engine B&S

T/380  
TBT 380  
MX MH 81-50R



HONDA-MOTOR/  
ENGINE/MOTEUR

Nicht abgebildet /  
Not shown

17B		30
HONDA - Motor, Engine HONDA		29
BL 5081 GT ,21B-385A684		28
17C		
HONDA - Motor, Engine HONDA		
BL 5081 GT ,21C-385D684		
BL 5081 GT ,21B-385D684		

E3-01990B-01