

T 380/50 > 21B-382A678 (2007) > KEILRIEMEN, SPANNROLLE

M 380 M , T/380 M , T/380 , TBT 380, T/380 B ,
 MX MH 81-55R ,MX MH 81-50R ,
 BL 5081 GT

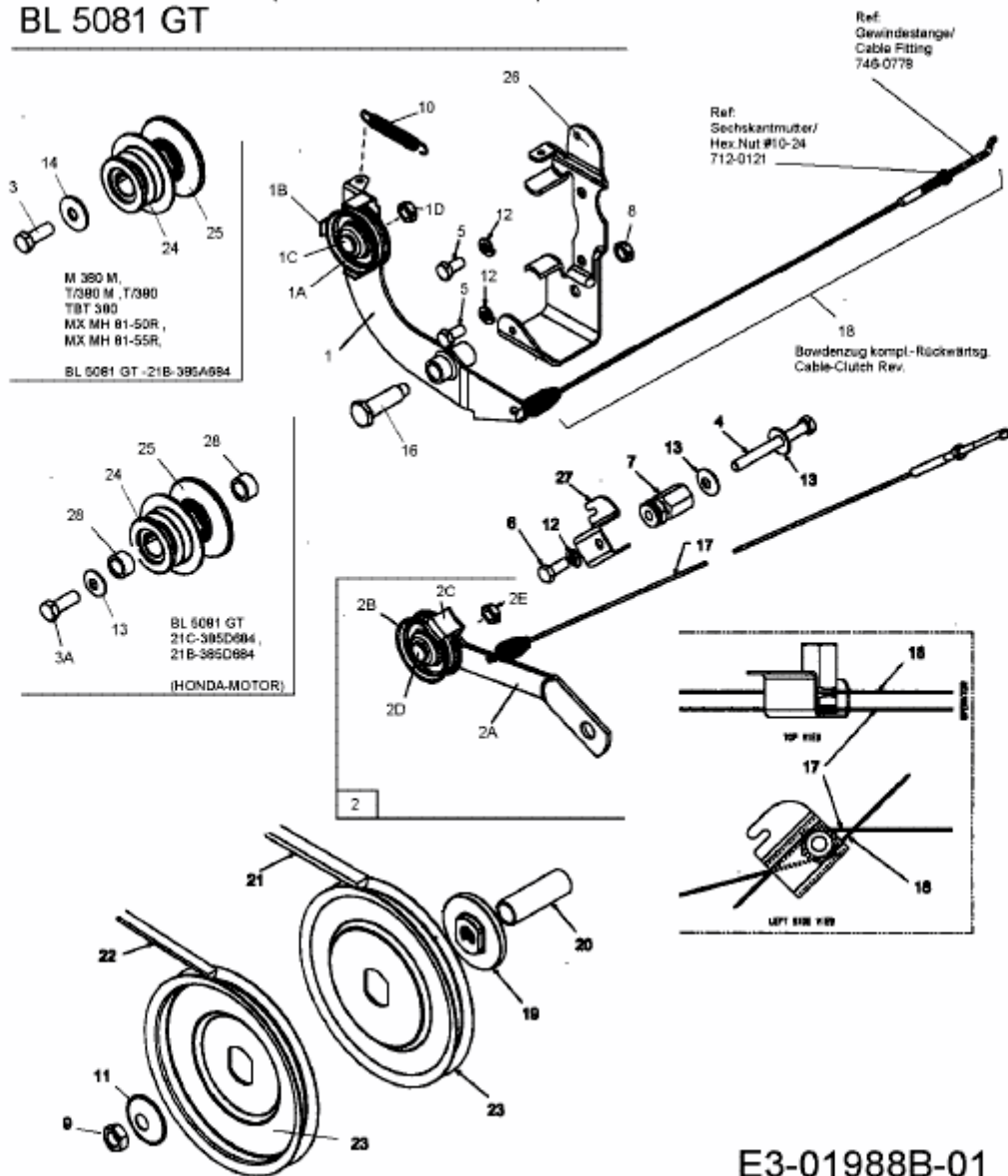

E3-01988B-01