

T/380 — 21A-382A678
YM 5032 TH — 21A-385A643
H 8050 H — 21A-385A690
TS MH 81-50R — 21B-382A667

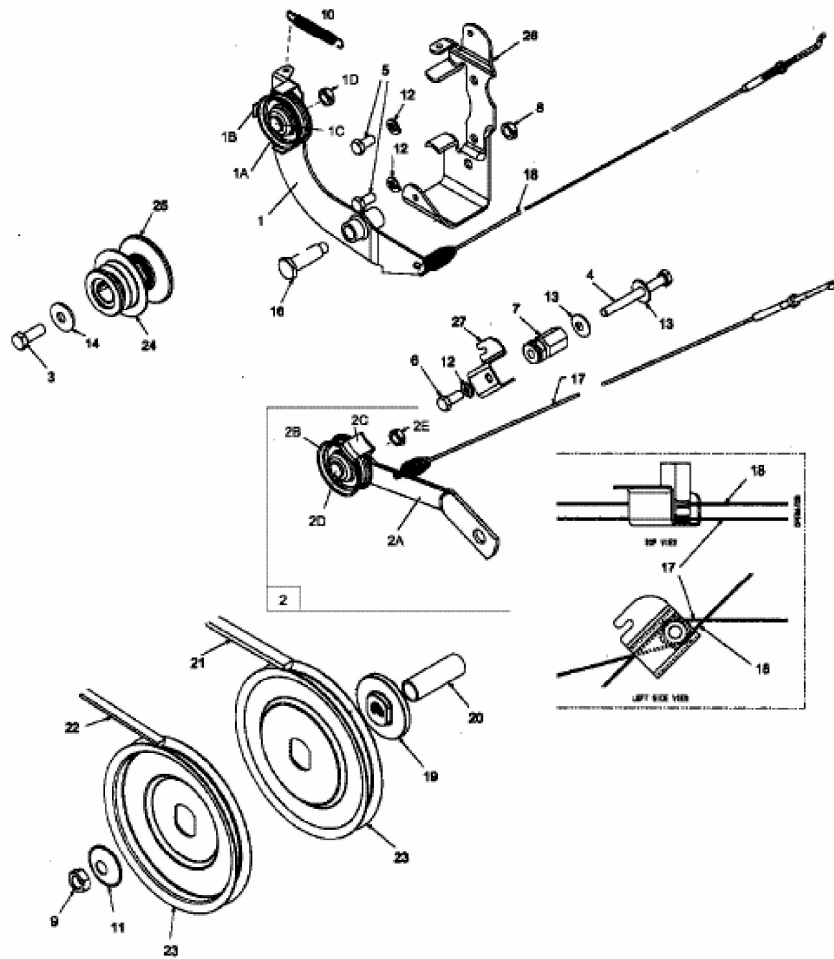

E3-01988A