

T/405 M > 21AA46M3678 (2012) > KEILRIEMENSCHUTZ

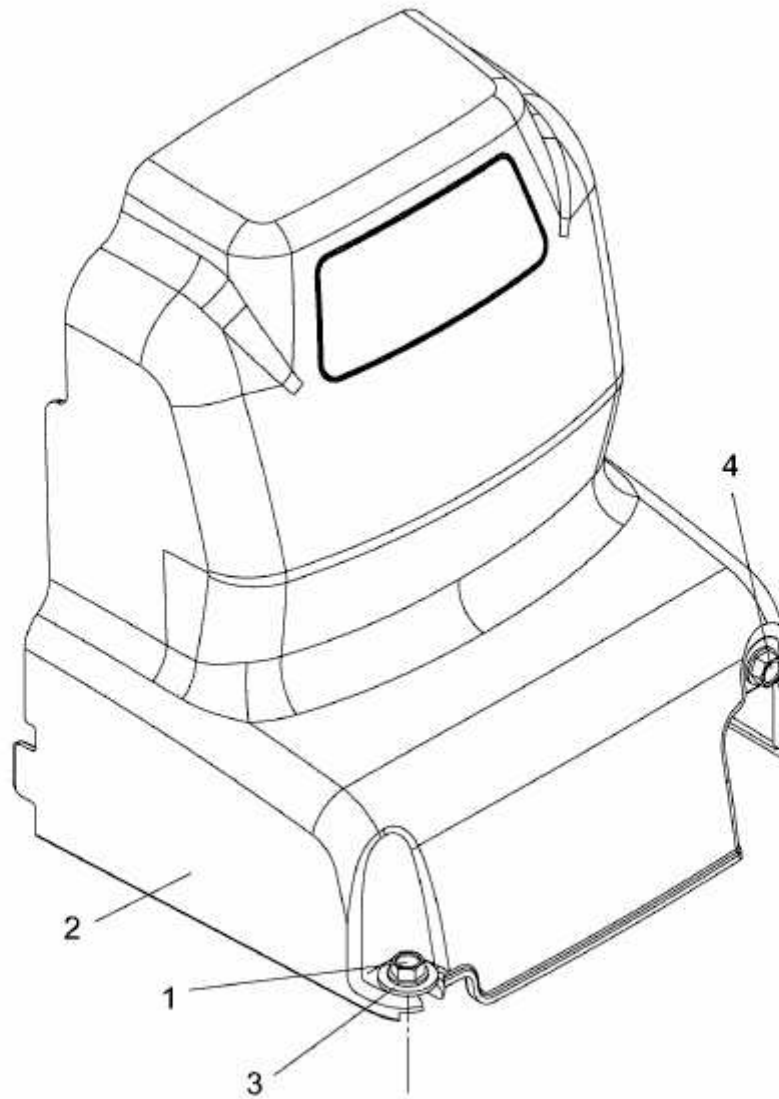

E3-05382A-01