

T/405 M > 21AA46M3678 (2012) > FRÄSGEHÄUSE

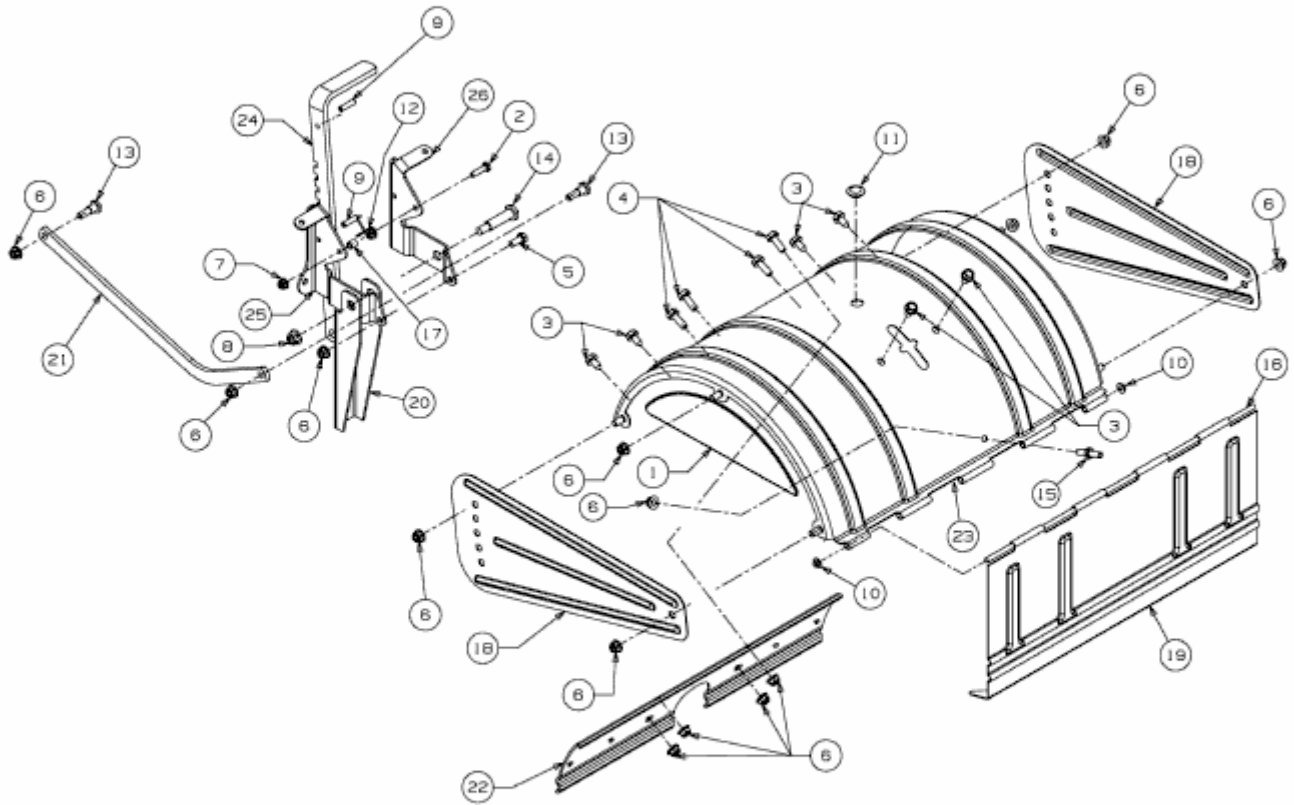

E3-05380A-01