

RT 45 > 21AA40M8710 (2016) > KEILRIEMENSCHUTZ

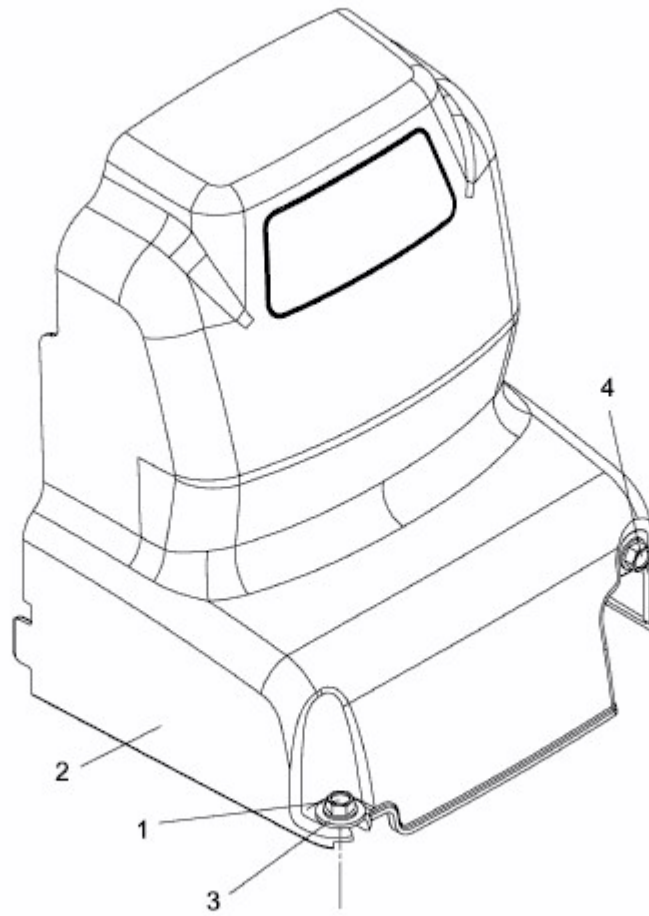

E3-05382A-01