

T/380

YM 6032 T

H 8060

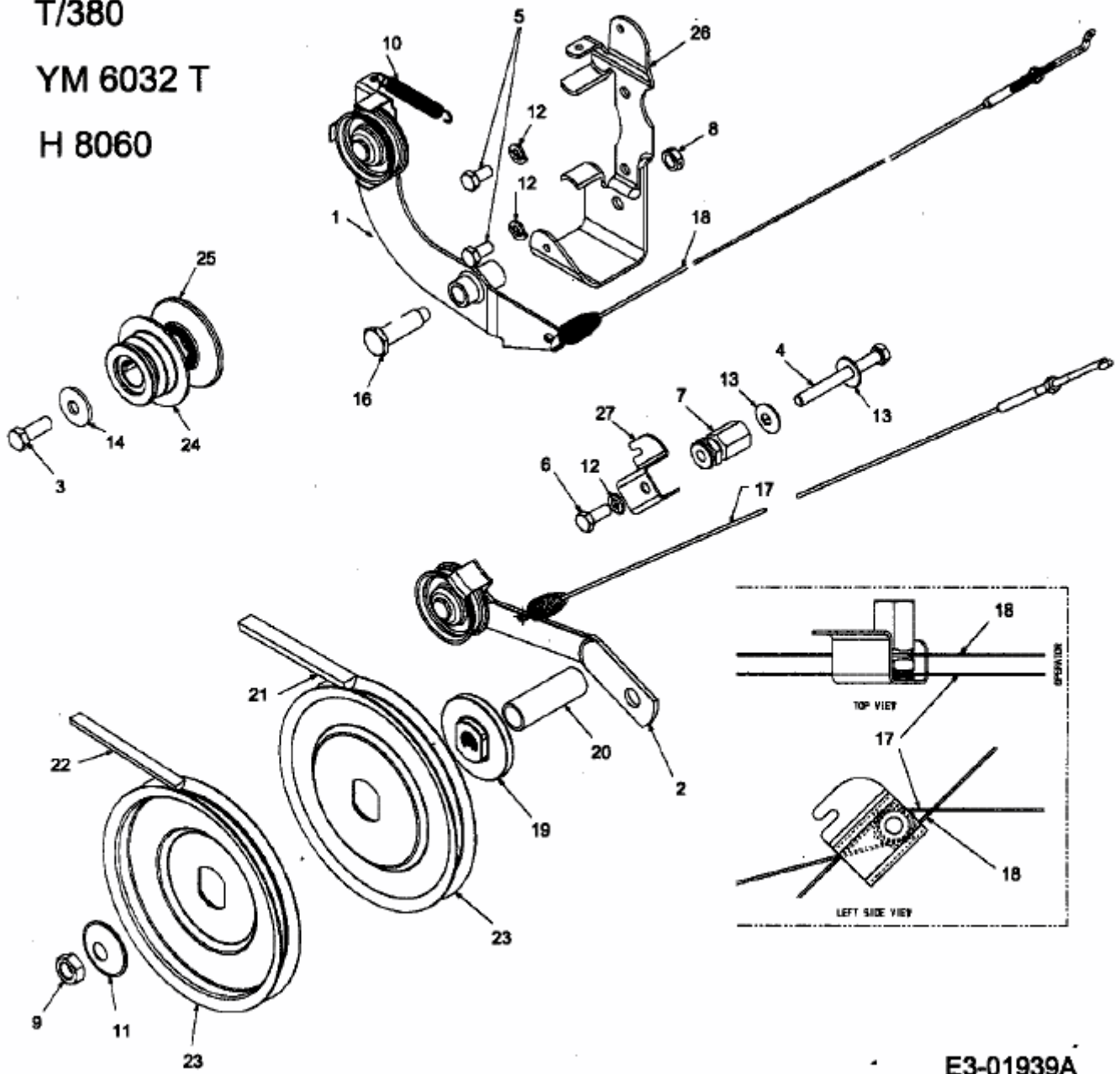

E3-01939A