

T/380

YM 6032 T

H 8060

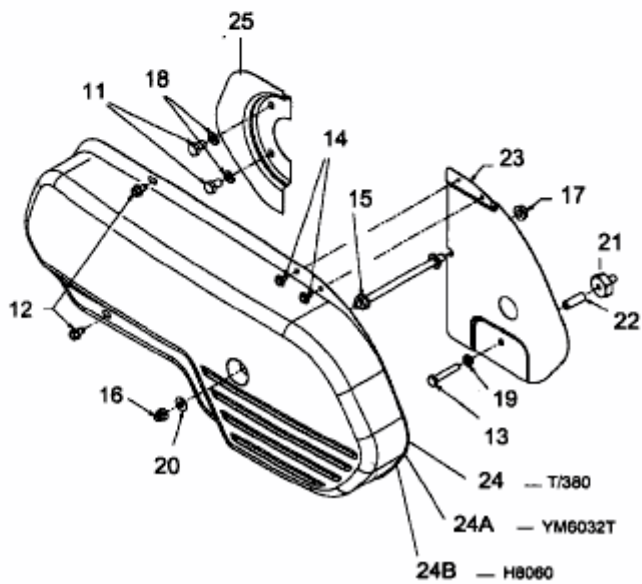
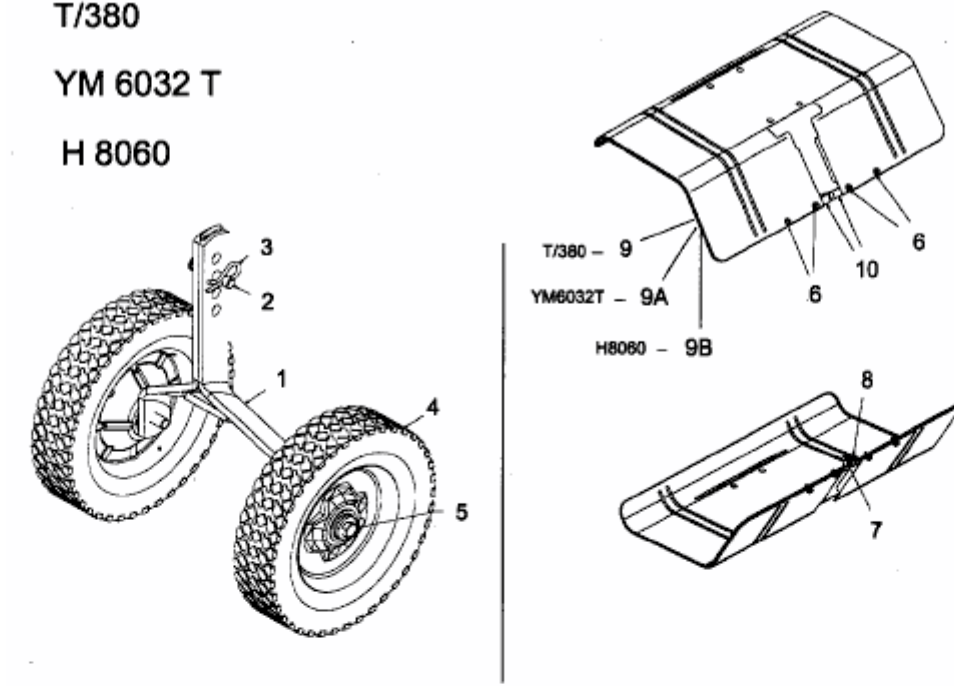

E3-01940A