

T/205 > 21A-20MI678 (2010) > GRUNDGERÄT

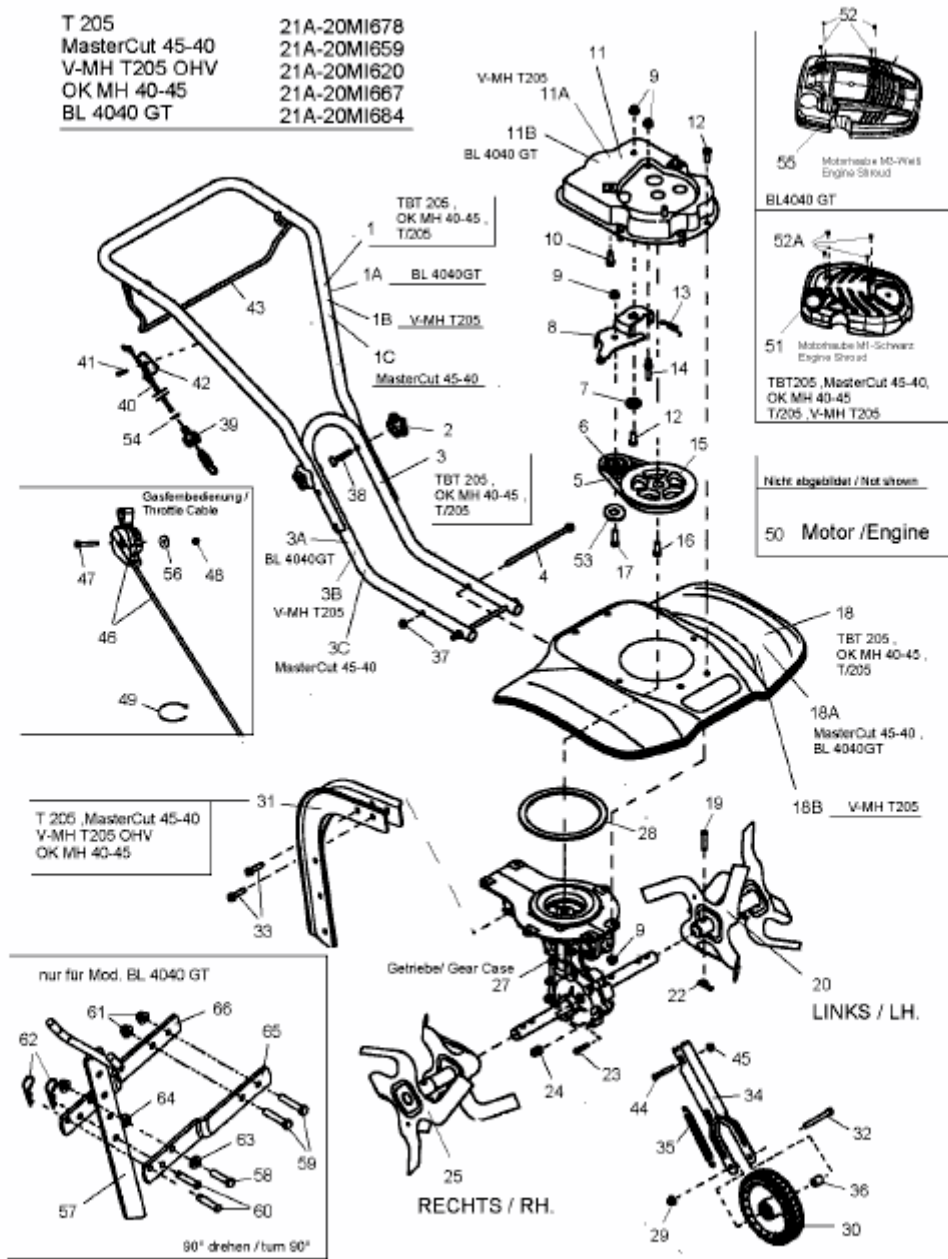

E3-02560C-01