

FÜR ALL ROUNDER 1050 > 19A70006100 (2013) > HIGHLIFT-MESSER, UNTERE RÖHREN

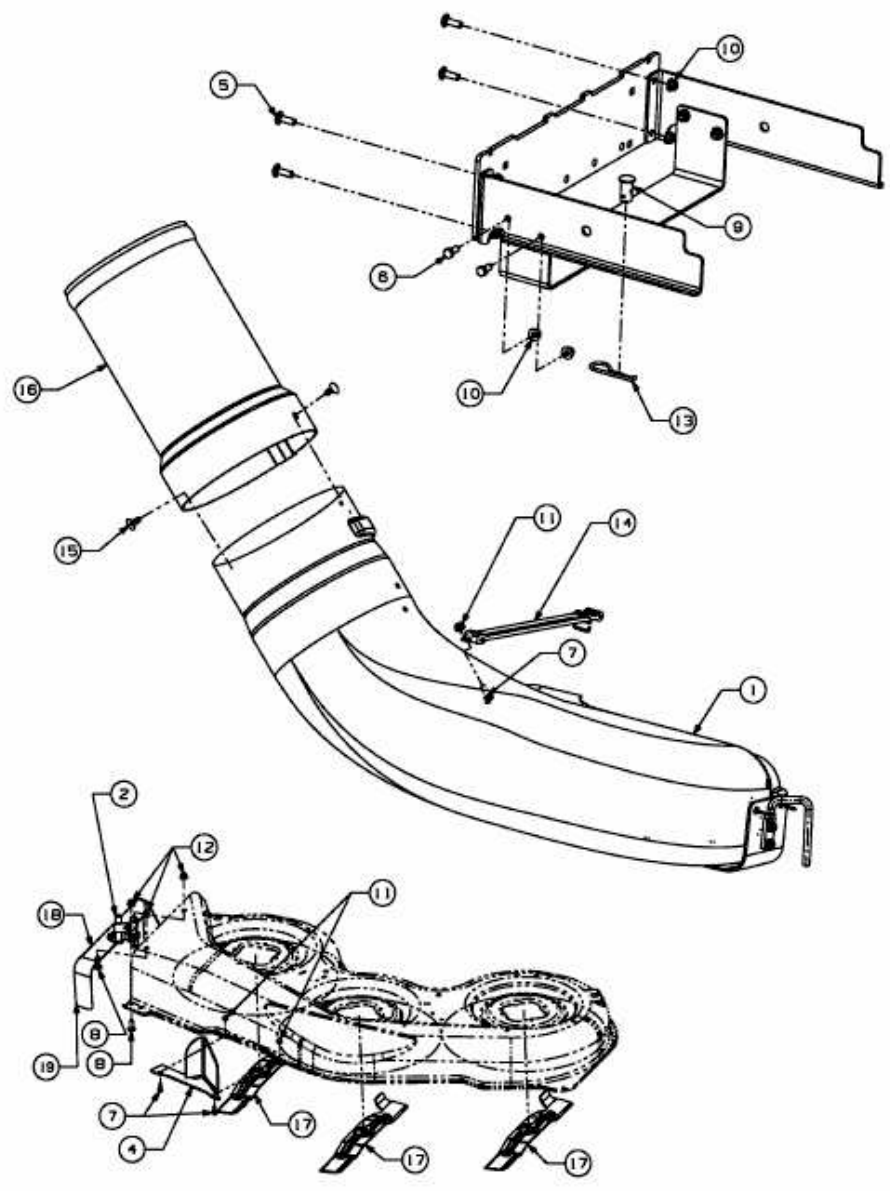

E3-07224A-01