

FÜR BM 87-35 > 196A758-678 (2017) > GRUNDGERÄT

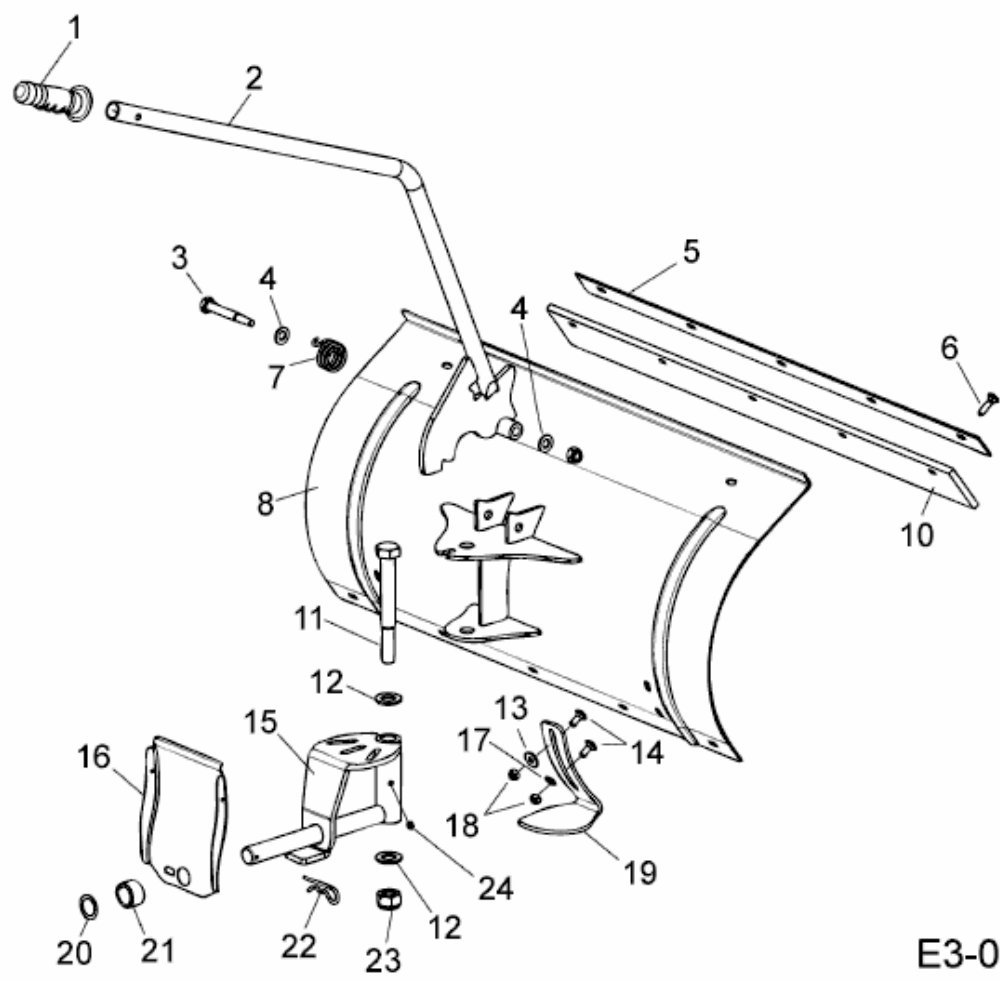

E3-09433A-01