

FÜR BM 87-50 > 196A755-678 (2016) > GRUNDGERÄT

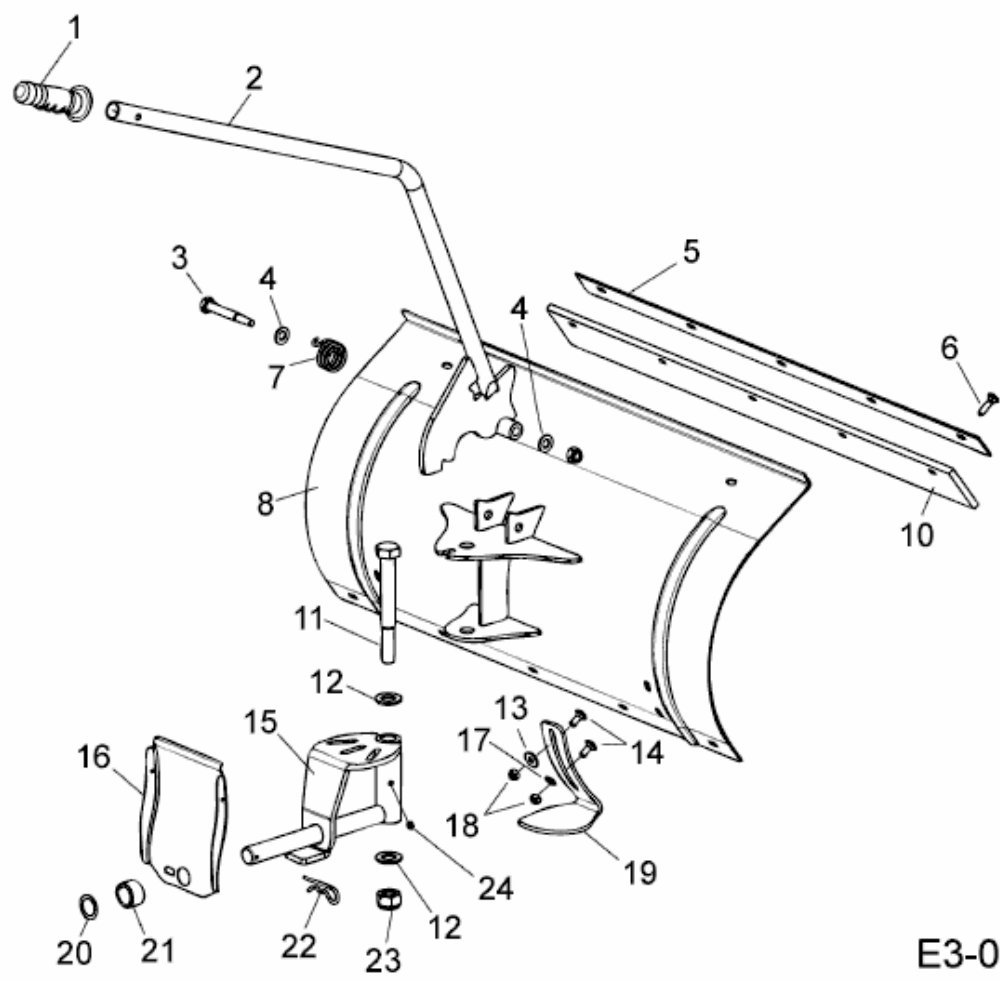

E3-09433A-01