

KEHRGUTBEHÄLTER 70 CM > 196A067-000 (2017) > GRUNDGERÄT

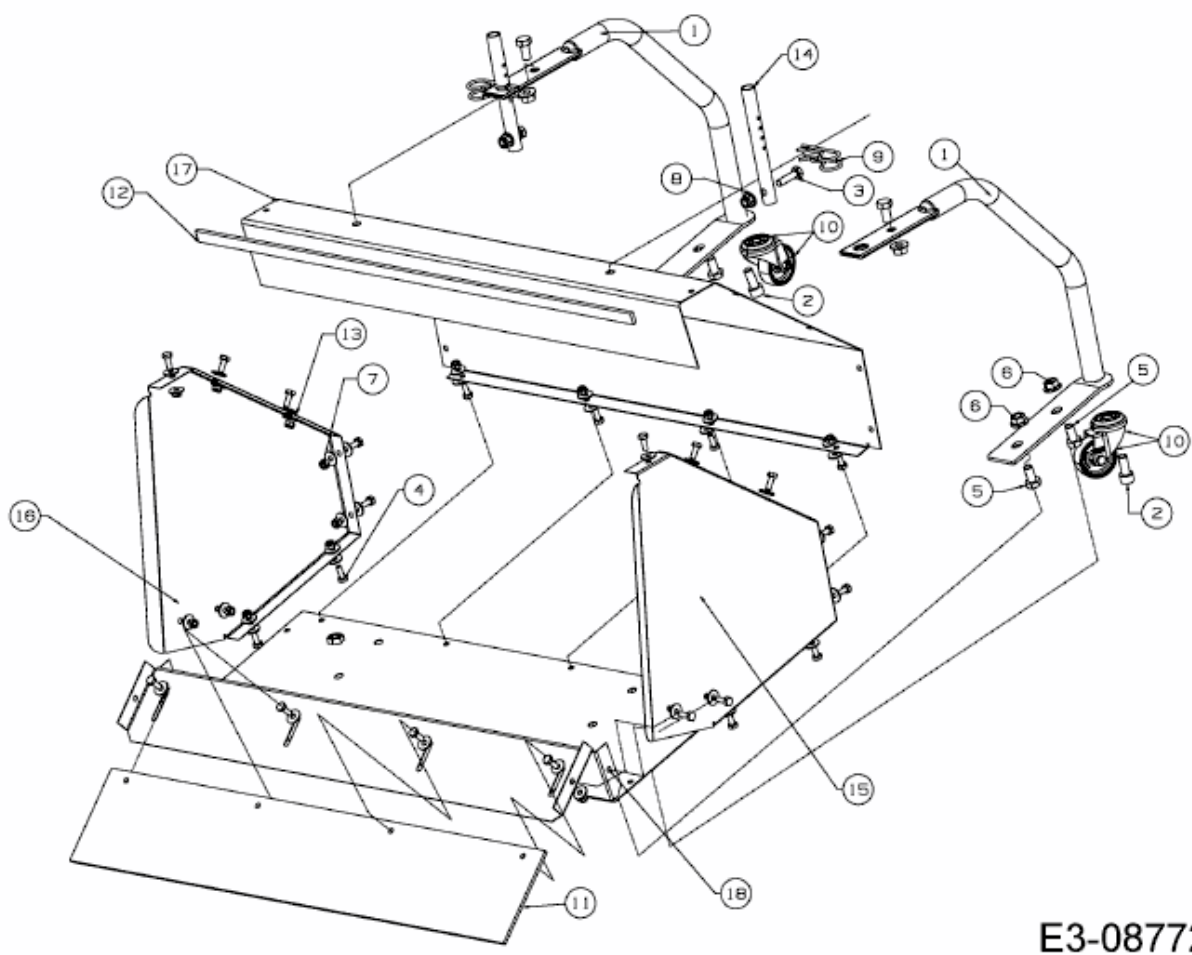

E3-08772B-01