

45-01716A-100 (196-541-000) > 196-541-000 (2017) > GRUNDGERÄT

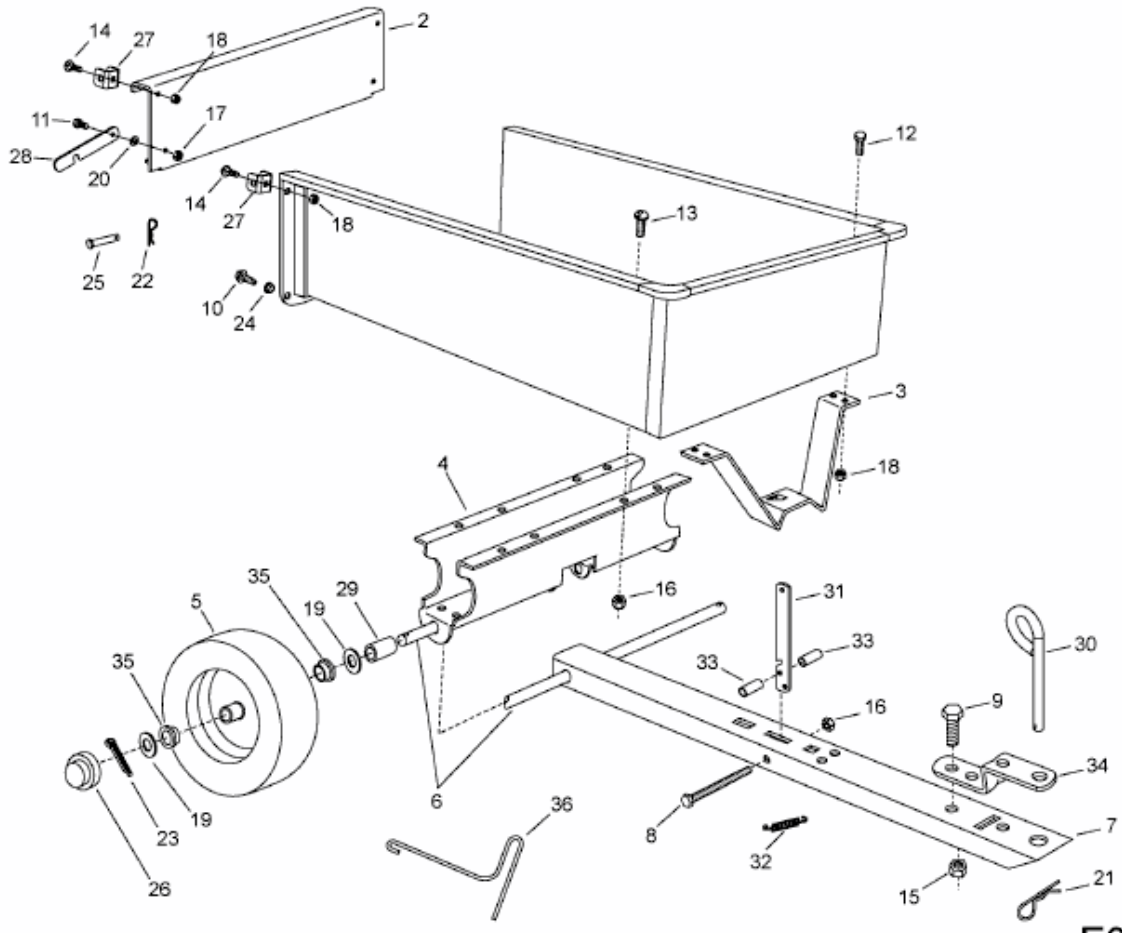

E3-08824A-01