

45-0369 (196-521-000) > 196-521-000 (2013) > GRUNDGERÄT

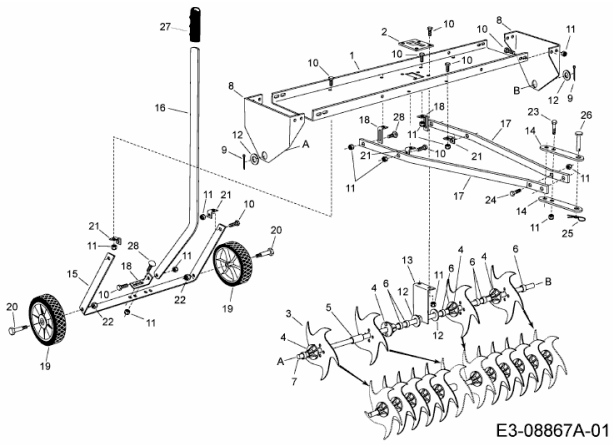

E3-08867A-01