

45-0350 (196-511-000) > 196-511-000 (2008) > GRUNDGERÄT

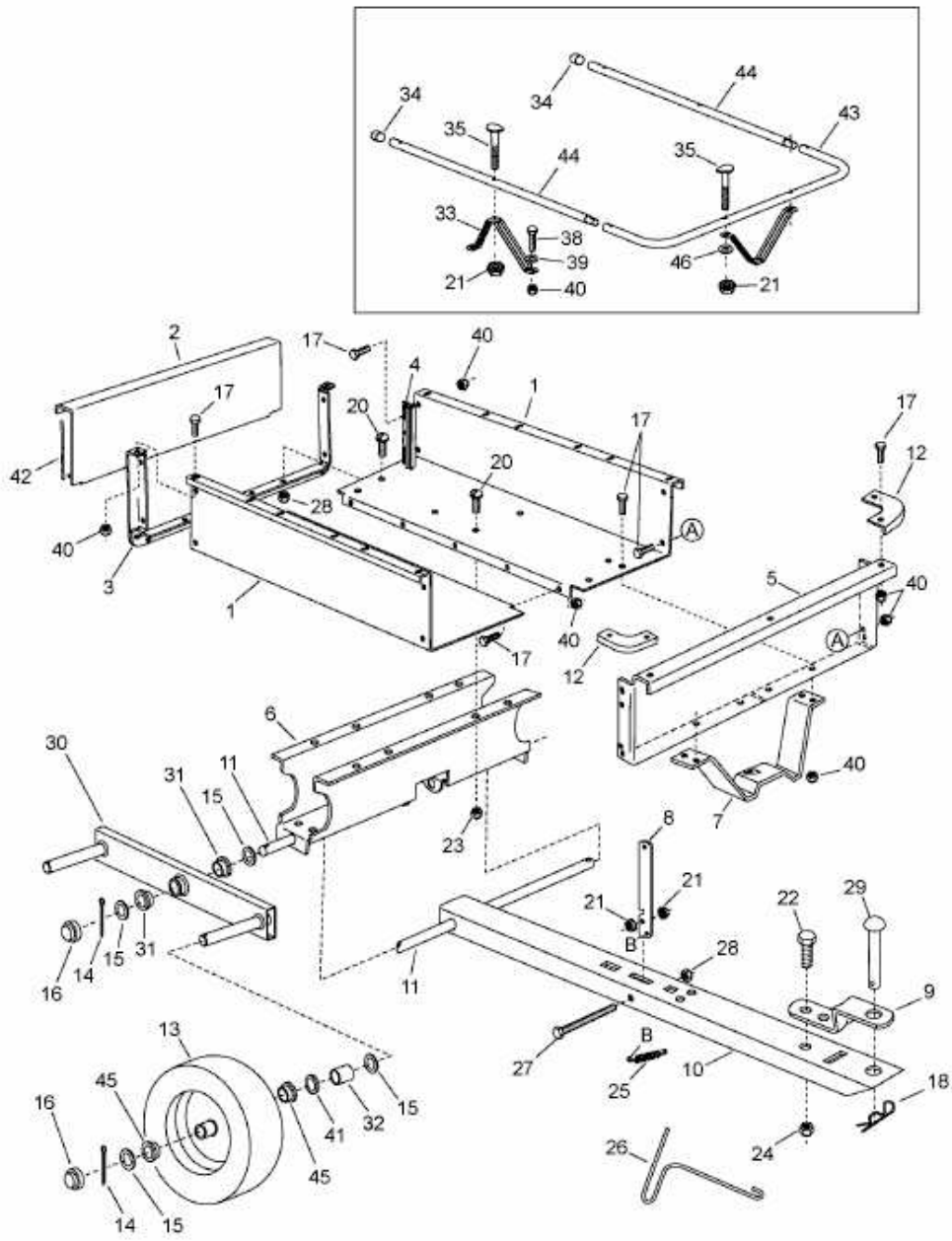

E3-02648A-01