

45-03433 (196-504-000) > 196-504-000 (2013) > GRUNDGERÄT

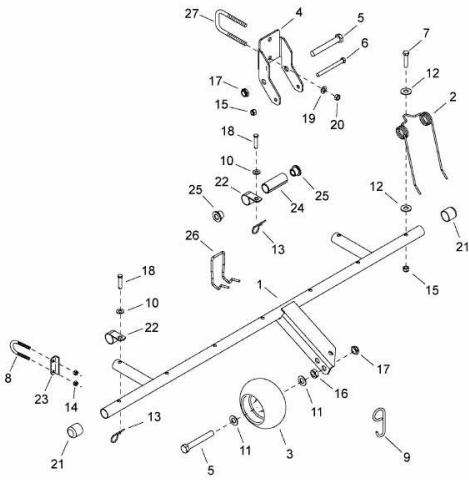

E3-08866C-01