

---

45-03431 (196-504-000) > 196-504-000 (2010) > GRUNDGERÄT

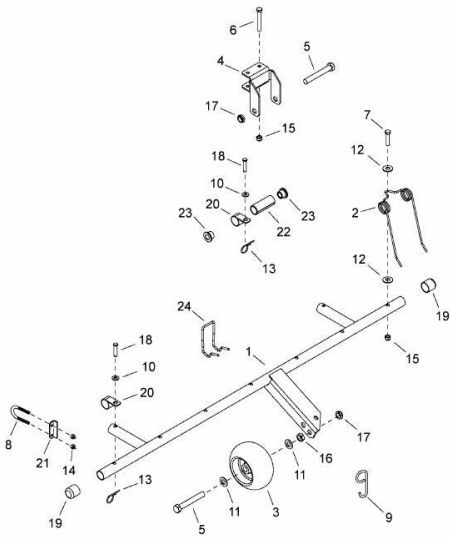

E3-08866B-01