

---

45-0343 (196-504-000) > 196-504-000 (2006) > GRUNDGERÄT

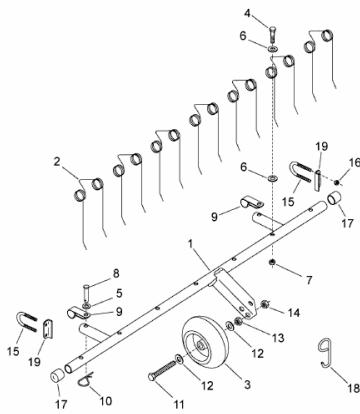

E3-08866A-01