

FÜR 400 SERIE > 196-180A699 (2007) > GRUNDGERÄT

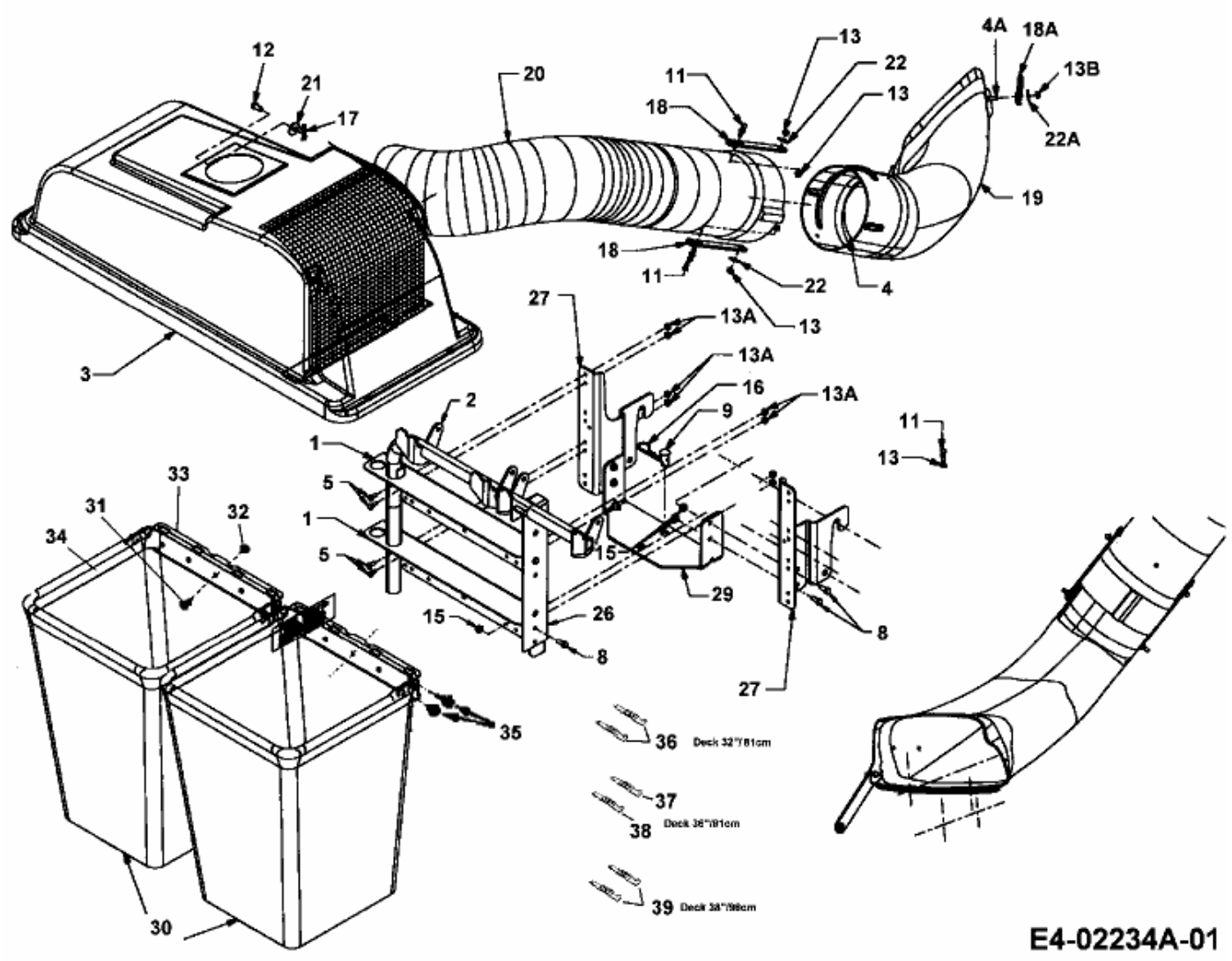

E4-02234A-01