

FÜR 400 SERIE > 196-180A678 (2008) > GRUNDGERÄT

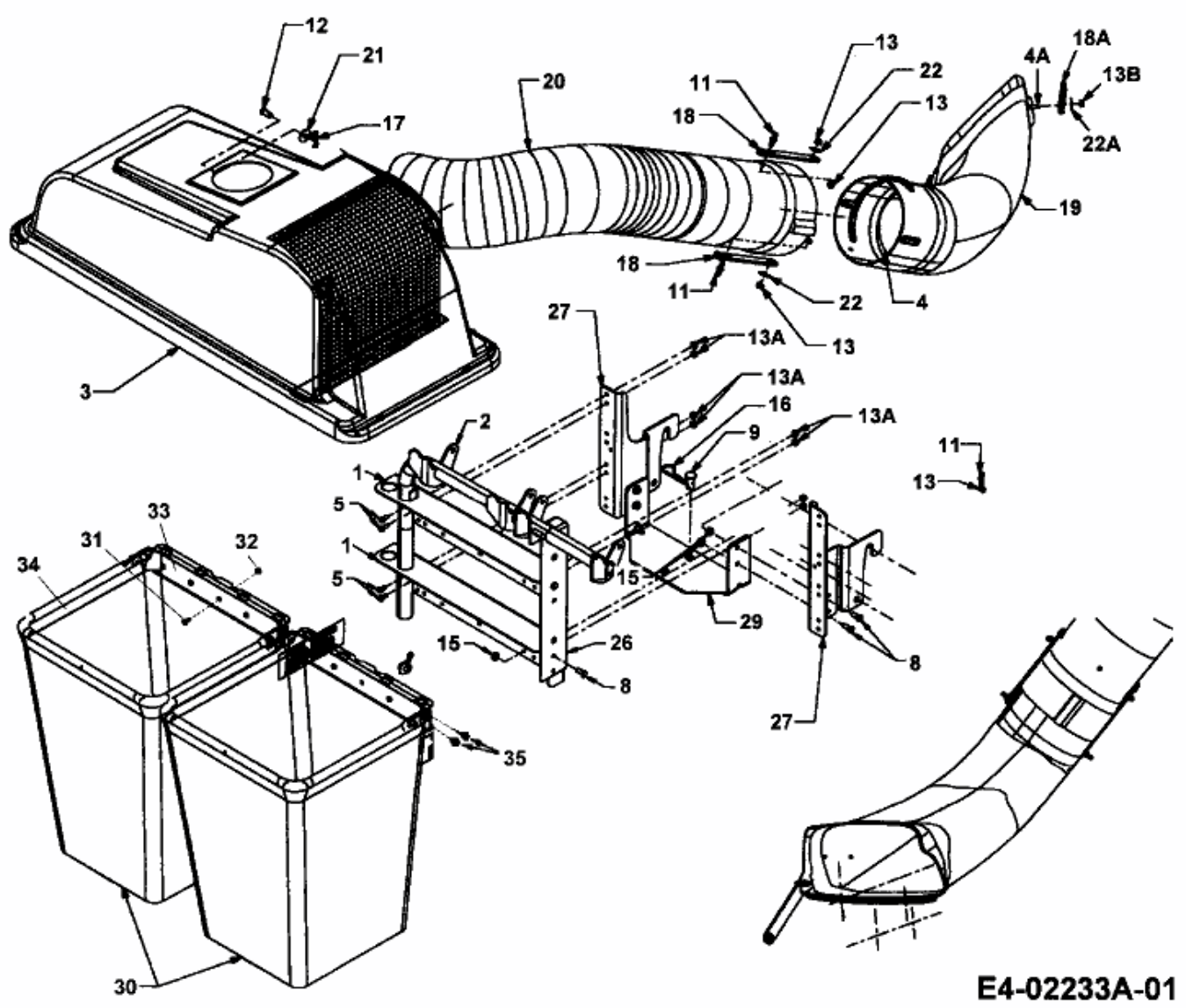

E4-02233A-01